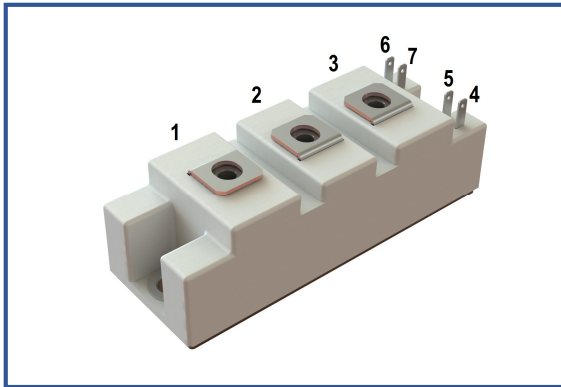

Industry standart 34mm IGBT module

1200 V 200 A

Chip features

- IGBT chip
 - Trench FS — V-Series IGBT (6th gen)
 - low $V_{CE(sat)}$ value
 - 10 μ s short circuit of 150°C
 - square RBSOA of 2xI_C
 - low EMI
- FRD chip
 - fast and soft reverse recovery
 - low voltage drop

Design features

- copper baseplate
- Al₂O₃ DBC substrate
- ultrasonically welded power terminals
- Improved thermal cycling
- RoHS compliant

Typical application

- AC motor drivers
- solar inverter
- air conditioning
- high power converters and UPS

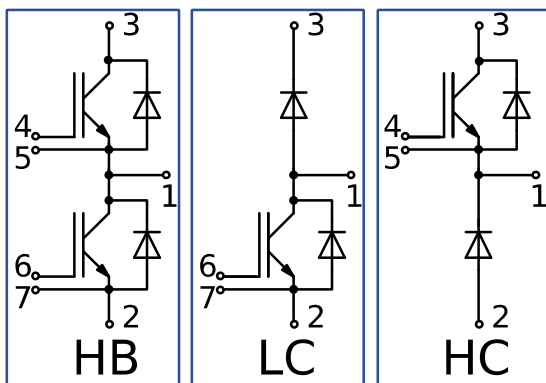
Maximum rated values

Definition	Symbol	Conditions	Value	Unit
IGBT				
Collector-Emitter voltage	V_{CES}	$V_{GE} = 0$.	1200	V
Collector current (nominal)	$I_{C\ nom}$		200	A
Collector current (maximum continuous)	$I_{C\ 25}$	$T_{vj\ (max)} = 175^{\circ}C; T_c = 25^{\circ}C$.	300	A
	$I_{C\ 80}$	$T_{vj\ (max)} = 175^{\circ}C; T_c = 80^{\circ}C$.	230	A
Repetitive peak collector current* ¹	I_{CRM}	$I_{CRM} = 3 \times I_{C\ nom}; t_p = 1\ ms$.	600	A
Short-circuit duration	t_{psc}	$T_{vj} = 25^{\circ}C; V_{GE} = \pm 15\ V; V_{CE} = 720\ V;$ $R_{G\ on} = R_{G\ off} = 3\ \Omega; I_{C\ max} < 750\ A$.	10	μ s
		$T_{vj} = 150^{\circ}C; V_{GE} = \pm 15\ V; V_{CE} = 720\ V;$ $R_{G\ on} = R_{G\ off} = 3\ \Omega; I_{C\ max} < 620\ A$.	10	
Gate-Emitter voltage	V_{GES}		± 20	V
Junction operating temperature	$T_{vj\ (op)}$		-40...+150	°C
Inverse diode \ Freewheeling diode				
Repetitive peak reverse voltage	V_{RRM}	$V_{GE} = 0\ V$.	1200	V
Forward current (nominal)	$I_{F\ nom}$		200	A
Forward current (maximum continuous)	$I_{F\ 25}$	$T_{vj\ (max)} = 175^{\circ}C; T_c = 25^{\circ}C$.	235	A
	$I_{F\ 80}$	$T_{vj\ (max)} = 175^{\circ}C; T_c = 80^{\circ}C$.	176	A
Repetitive peak forward current* ¹	I_{FRM}	$I_{FRM} = 3 \times I_{F\ nom}; t_p = 1\ ms$.	600	A
Junction operating temperature	$T_{vj\ (op)}$		-40...+150	°C
Module				
Storage temperature	T_{stg}		-40...+50	°C
Isolation voltage	V_{isol}	AC sin 50 Hz; t = 1 min.	4000	V

*¹ Pulse width and repetition rate should be such that device junction temperature does not exceed maximum T_{vj}

Characteristics

Definition	Symbol	Conditions	Value			Unit		
			min.	typ.	max.			
IGBT								
Collector-Emitter saturation voltage	V_{CEsat}	$V_{GE} = +15\text{ V}; I_C = 200\text{ A};$ $t_u = 1000\text{ }\mu\text{s}.$	$T_{vj} = 25^\circ\text{C}$ $T_{vj} = 150^\circ\text{C}$	1.88 2.31	1.93 2.41	2.10 2.70	V V	
Gate-Emitter threshold voltage	$V_{GE(th)}$	$I_C = 7\text{ mA}; V_{CE} = V_{GE};$ $T_{vj} = 25^\circ\text{C};$ $t_u = 2\text{ ms}.$		5.45	5.85	6.45	V	
Collector-Emitter cut-off current	I_{CES}	$V_{CE} = 1200\text{ V};$ $t_u = 10\text{ ms}; V_{GE} = 0.$	$T_{vj} = 25^\circ\text{C}$ $T_{vj} = 150^\circ\text{C}$	2.40 0.87	2.74 1.20	150 1.60	μA mA	
Gate-Emitter leakage current	I_{GES}	$V_{CE} = 0; V_{GE} = \pm 20\text{ V};$ $T_{vj} = 25^\circ\text{C};$ $t_u = 30\text{ ms}.$		10.1	13.6	250	nA	
Input capacitance	C_{ies}	$V_{CE} = 10\text{ V}; V_{GE} = 0\text{ V};$ $f = 1\text{ MHz}; T_{vj} = 25^\circ\text{C}.$		-	16.6	-	nF	
Output capacitance	C_{oes}		-	1.20	-	nF		
Reverse transfer capacitance	C_{res}		-	1.40	-	nF		
Total gate charge	Q_G	$I_C = 200\text{ A}; V_{CE} = 600\text{ V};$ $V_{GE} = -8 \div 15\text{ V}.$		-	1784	1915	nC	
Internal gate resistance	R_{Gint}	$T_{vj} = 25^\circ\text{C}.$		-	3.75	-	Ω	
Turn-on delay time	$t_{d(on)}$	$V_{CE} = 600\text{ V};$ $V_{GE} = \pm 15\text{ V};$ $I_{Cmax} = 200\text{ A};$ $R_G = 3\text{ }\Omega;$ $L = 300\text{ }\mu\text{H}.$	$T_{vj} = 25^\circ\text{C}$ $T_{vj} = 150^\circ\text{C}$	324 370	373 429	425 475	ns	
Rise time	t_{ri}		$T_{vj} = 25^\circ\text{C}$ $T_{vj} = 150^\circ\text{C}$	50.0 57.0	52.7 58.1	60.0 67.0	ns	
Turn-on energy	E_{on}		$T_{vj} = 25^\circ\text{C}$ $T_{vj} = 150^\circ\text{C}$	7.14 13.2	8.18 15.0	9.70 17.9	mJ	
Turn-off delay time	$t_{d(off)}$		$T_{vj} = 25^\circ\text{C}$ $T_{vj} = 150^\circ\text{C}$	412 484	454 530	510 605	ns	
Fall time	t_{fi}		$T_{vj} = 25^\circ\text{C}$ $T_{vj} = 150^\circ\text{C}$	162 322	231 357	350 490	ns	
Turn-off energy	E_{off}		$T_{vj} = 25^\circ\text{C}$ $T_{vj} = 150^\circ\text{C}$	14.8 20.8	15.6 22.5	20.0 24.7	mJ	
Collector-emitter threshold voltage	V_{CE0}		$V_{GE} = +15\text{ V}; T_{vj} = 150^\circ\text{C};$		0.82	0.84	0.92	V
On-State slope resistance (IGBT)	r_{CE0}		$I_{CE1} = 50\text{ A}; I_{CE2} = 200\text{ A};$ $t_u = 1000\text{ }\mu\text{s}.$		7.47	7.86	8.90	m Ω
Thermal resistance junction to case	$R_{th(j-c)}$		DC; $I_{CE} = 200 \pm 20\text{ A}; I_{test} = 0.5\text{ A};$ $V_{GE} = +15\text{ V}.$		-	0.133	0.140	K/W
Inverse diode \ Freewheeling diode								
Forward voltage drop	V_F	$I_F = 200\text{ A};$ $V_{GE} = 0; t_u = 1000\text{ }\mu\text{s}.$	$T_{vj} = 25^\circ\text{C}$ $T_{vj} = 150^\circ\text{C}$	1.83 2.00	1.87 2.06	2.05 2.25	V V	
Reverse recovery time	t_{rr}	$V_{GE} = \pm 15\text{ V};$ $V_{CE} = 600\text{ V};$ $I_{Cmax} = 200\text{ A};$ $R_{Gon} = 3\text{ }\Omega;$ $L = 300\text{ }\mu\text{H}.$	$T_{vj} = 25^\circ\text{C}$ $T_{vj} = 150^\circ\text{C}$	120 450	124 450	140 505	ns ns	
Repetitive peak reverse current	I_{rrm}		$T_{vj} = 25^\circ\text{C}$ $T_{vj} = 150^\circ\text{C}$	151 192	158 195	180 220	A A	
Reverse recovered charge	Q_{rr}		$T_{vj} = 25^\circ\text{C}$ $T_{vj} = 150^\circ\text{C}$	11.4 27.8	11.7 29.1	12.3 33.0	μC μC	
Reverse recovery energy	E_{rec}		$T_{vj} = 25^\circ\text{C}$ $T_{vj} = 150^\circ\text{C}$	5.12 12.2	5.45 13.1	7.00 15.0	mJ mJ	
Threshold voltage	$V_{(T0)}$		$T_{vj} = 150^\circ\text{C}; V_{GE} = 0; I_{CE1} = 50\text{ A};$		0.83	0.84	0.90	V
Forward slope resistance	r_T		$I_{CE2} = 200\text{ A}; t_u = 1000\text{ }\mu\text{s}$		5.80	6.09	6.65	m Ω
Thermal resistance junction to case	$R_{th(jc-D)}$	DC; $I_{CE} = 110 \pm 15\text{ A}; I_{test} = 0.5\text{ A};$ $V_{GE} = +15\text{ V}.$		-	0.263	0.268	K/W	

Module							
Pin resistance	R_{Pxy}	$T_{vj} = 25^{\circ}\text{C}.$	R_{P12}	-	0.47	0.50	mΩ
			R_{P13}	-	0.66	0.66	
Parasitic inductance between terminals	L_{Pxy}	$T_{vj} = 25^{\circ}\text{C};$ $f = 1 \text{ MHz}.$	L_{P12}	-	34.5	35.0	nH
			L_{P13}	-	52.3	60.0	
Thermal resistance case to heatsink	R_{thCH}	per module		-	0.02	0.04	K/W
Mounting torque for screws to heatsink	M_s	to heatsink M6		3.00	-	5.00	N*m
Mounting torque for terminal screws	M_t	to terminals M5		2.25	2.50	2.75	N*m
Weight	W			-	150	170	g

Notes:

- Insulating material operating temperature 125°C max;
- Case temperature 125°C max;
- The recommended operating junction temperature $T_{vj\ op} = -40 \div +150^{\circ}\text{C}.$

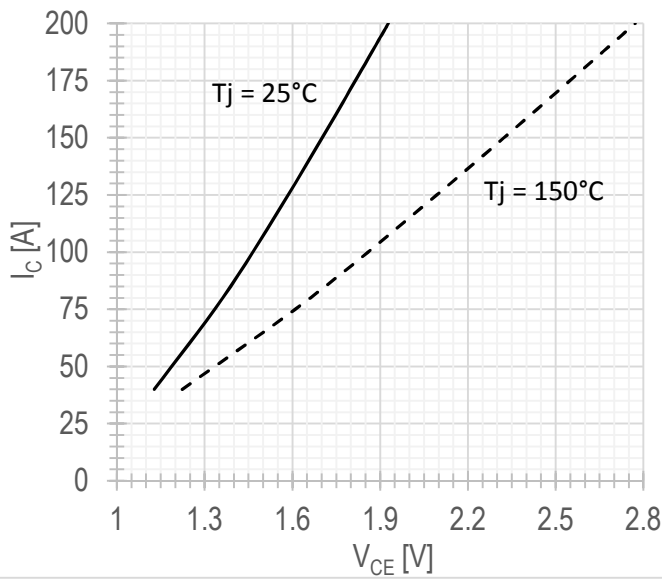
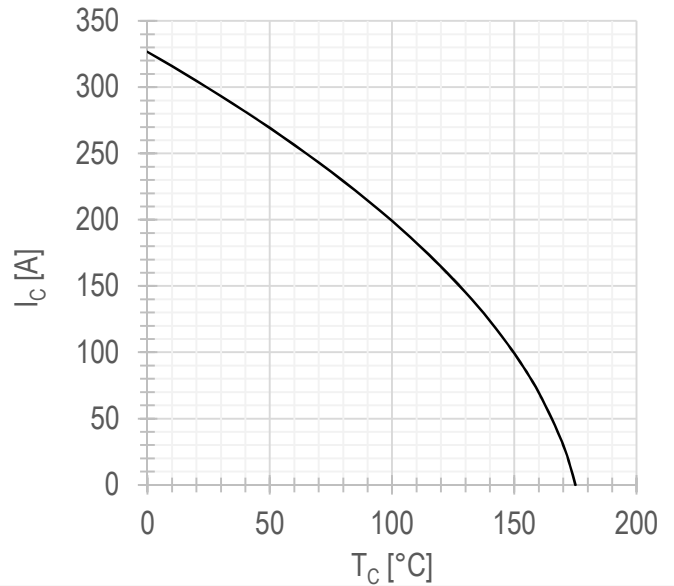
Chart 1 – typ. output characteristic, IGBT.

 $V_{GE} = +15 \text{ V.}$
Chart 2 – typ. rated current vs temperature.

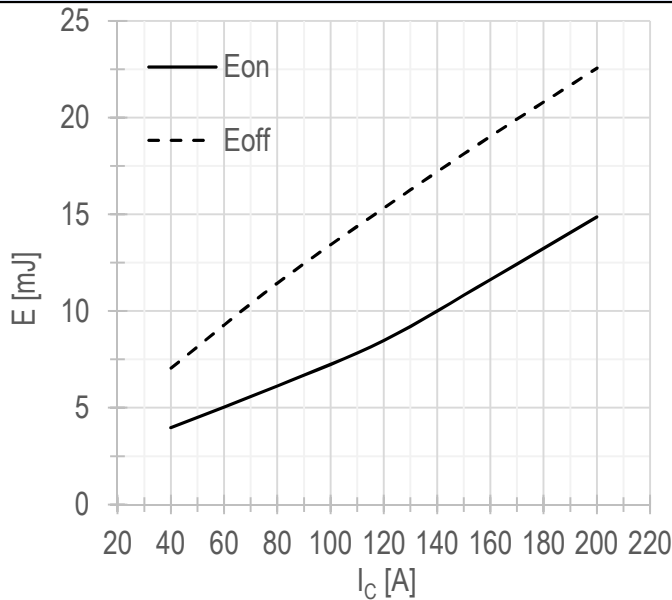
DC;
 $V_{GE} = +15 \text{ V;}$
 $T_{vj(max)} = 150^\circ\text{C.}$

Chart 3 – typ. turn-on/-off energy vs rated current, IGBT.

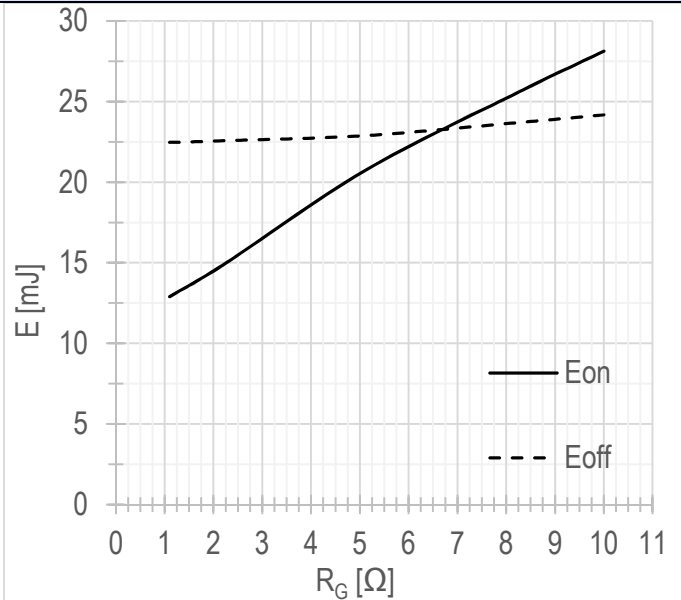
$V_{CE} = 600 \text{ V;}$
 $V_{GE} = \pm 15 \text{ V;}$
 $R_G = 3 \Omega;$
 $L = 300 \mu\text{H;}$
 $T_{vj(max)} = 150^\circ\text{C.}$

Chart 4 – typ. turn-on/-off energy vs gate resistance, IGBT.

$V_{CE} = 600 \text{ V;}$
 $V_{GE} = \pm 15 \text{ V;}$
 $I_{Cmax} = 200 \text{ A;}$
 $L = 300 \mu\text{H;}$
 $T_{vj(max)} = 150^\circ\text{C.}$

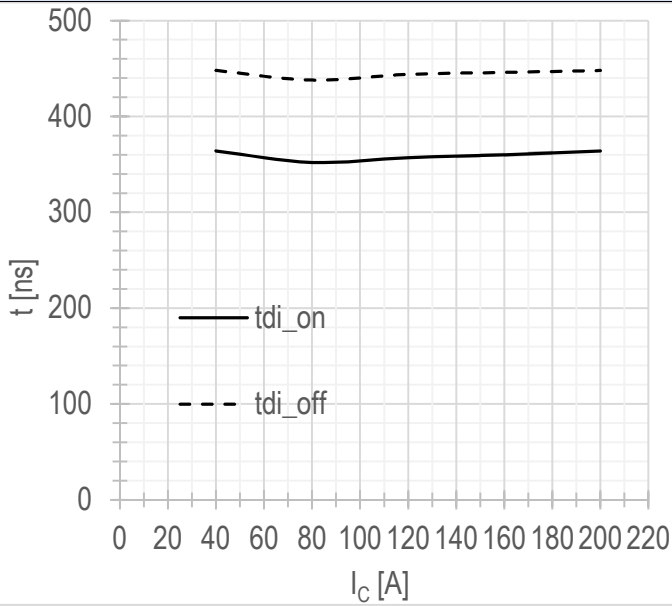
Chart 5 – typ. switching times vs rated current, IGBT.

$V_{CE} = 600$ V;
 $V_{GE} = \pm 15$ V;
 $R_G = 3$ Ω ;
 $L = 300$ μ H;
 $T_{vj(max)} = 150^\circ$ C.

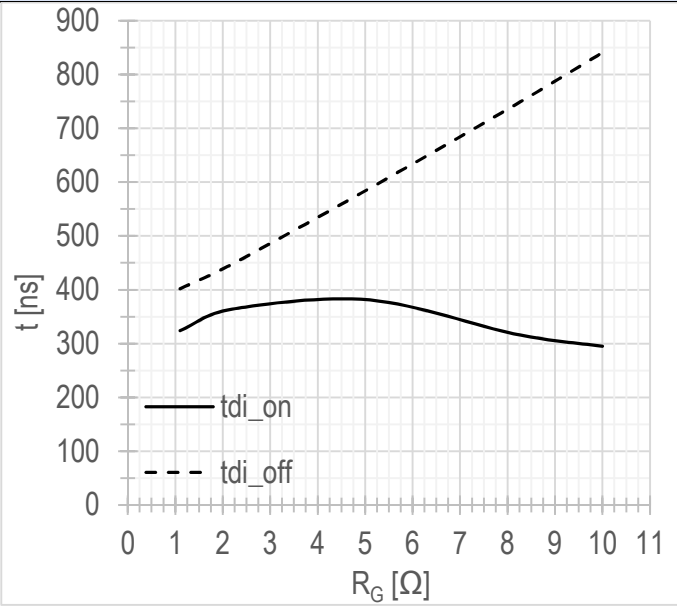
Chart 6 – typ. switching times vs gate resistance, IGBT.

$V_{CE} = 600$ V;
 $V_{GE} = \pm 15$ V;
 $I_{Cmax} = 200$ A;
 $L = 300$ μ H;
 $T_{vj(max)} = 150^\circ$ C.

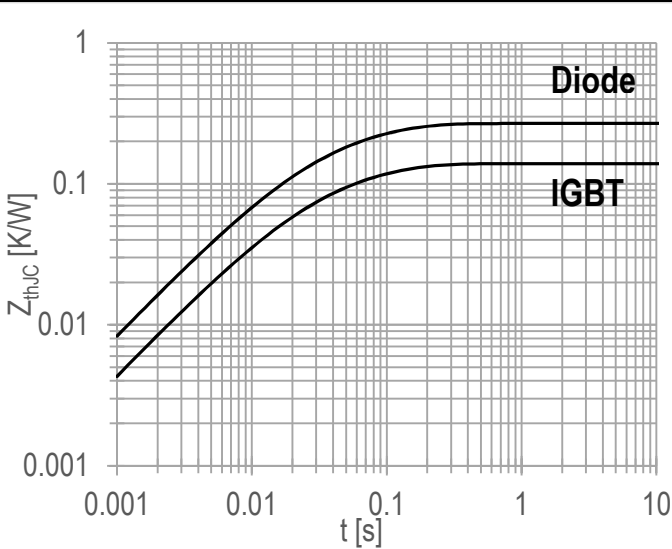
Chart 7 – max. transient thermal impedance .

Single pulse;
 $V_{GE} = +15$ V.

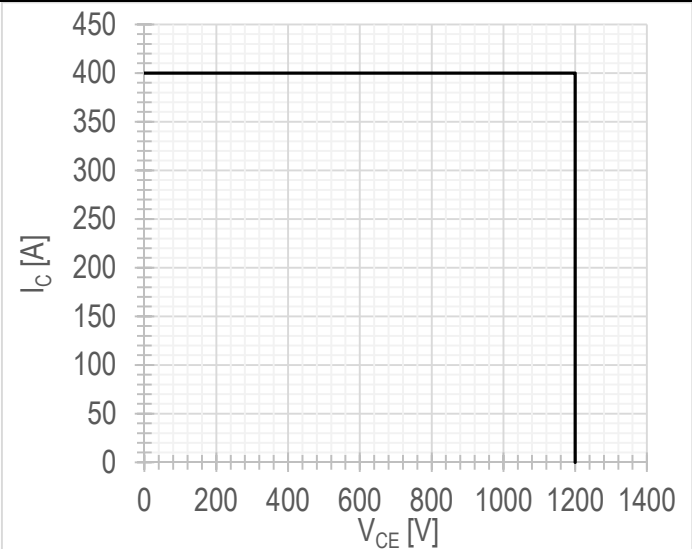
Chart 8 – RBSOA.

$V_{CEmax} = 1200$ V;
 $V_{GE} = \pm 15$ V;
 $I_{Cmax} = 2 * I_{Cnom}$;
 $L = 100$ μ H.

Chart 9 – typ. output characteristic, FRD.

 $V_{GE} = +15\text{ V}$.

Chart 10 – typ. switching losses vs rated current, FRD.

 $V_{GE} = \pm 15\text{ V}$;
 $V_{CE} = 600\text{ V}$;
 $L = 300\ \mu\text{H}$;
 $R_G = 3\ \Omega$.
 $T_{vj(max)} = 150^\circ\text{C}$.

Chart 11 – typ. switching losses vs gate resistance, FRD.

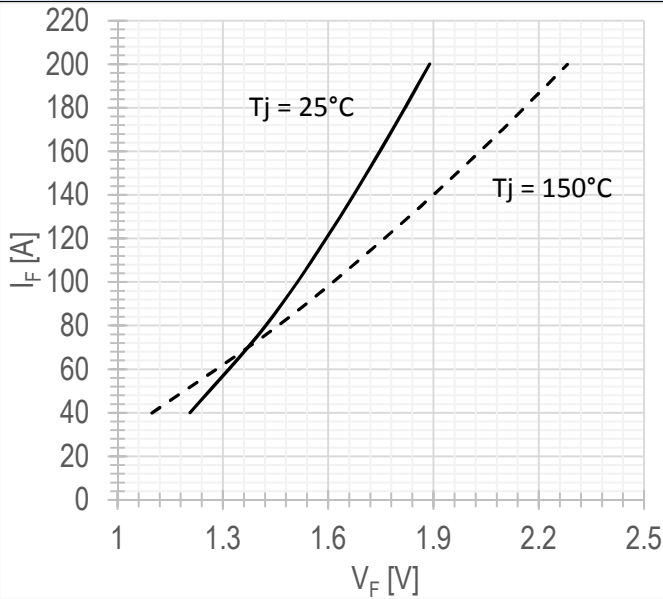
 $V_{GE} = \pm 15\text{ V}$;
 $V_{CE} = 600\text{ V}$;
 $I_{Cmax} = 200\text{ A}$;
 $L = 300\ \mu\text{H}$;
 $T_{vj(max)} = 150^\circ\text{C}$.

Chart 12 – typ. reverse recovered charge vs gate resistance, FRD.

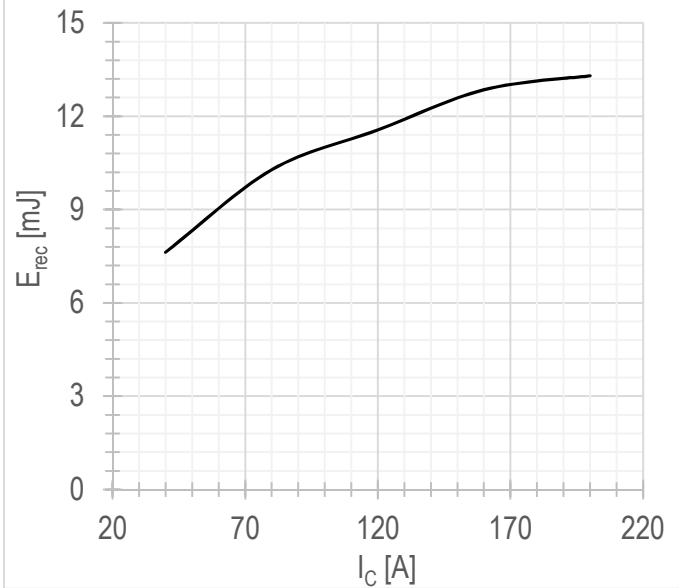
 $V_{GE} = \pm 15\text{ V}$;
 $V_{CE} = 600\text{ V}$;
 $I_{Cmax} = 200\text{ A}$;
 $L = 300\ \mu\text{H}$;
 $T_{vj(max)} = 150^\circ\text{C}$.

Chart 13 – typ. switching times vs rated current, FRD.

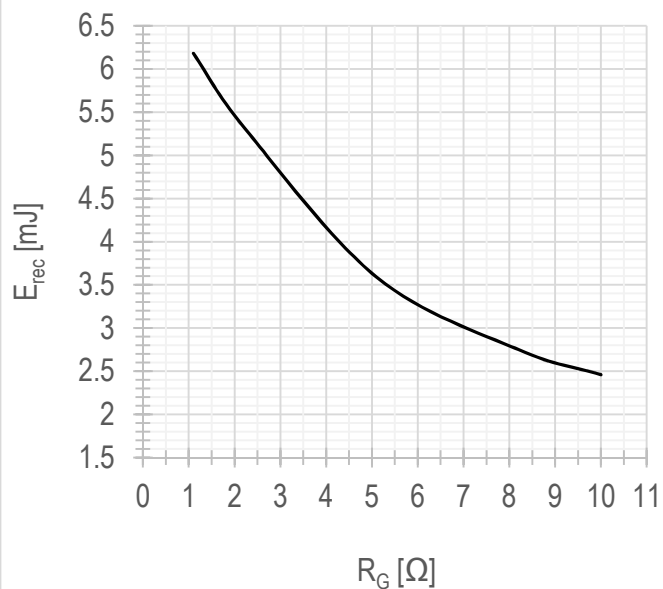
$V_{GE} = \pm 15$ V;
 $V_{CE} = 600$ V;
 $L = 300$ μ H;
 $R_G = 3$ Ω .
 $T_{vj(max)} = 150^\circ\text{C}$.

Chart 14 – typ. switching times vs gate resistance, FRD.

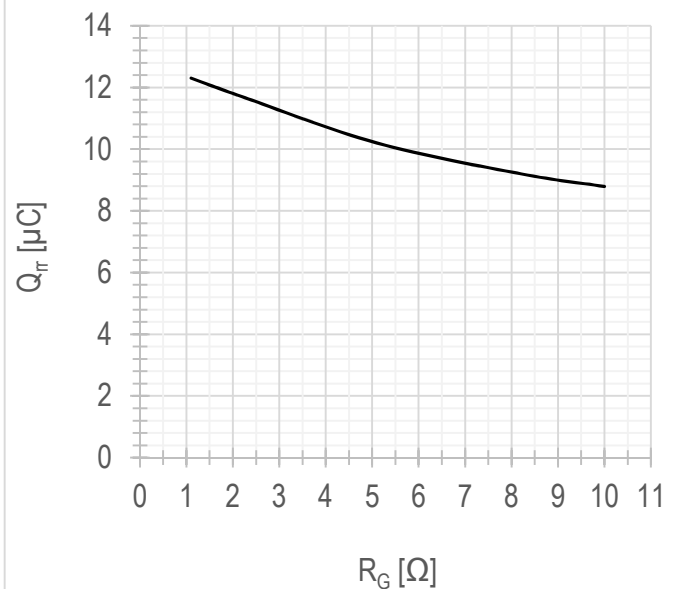
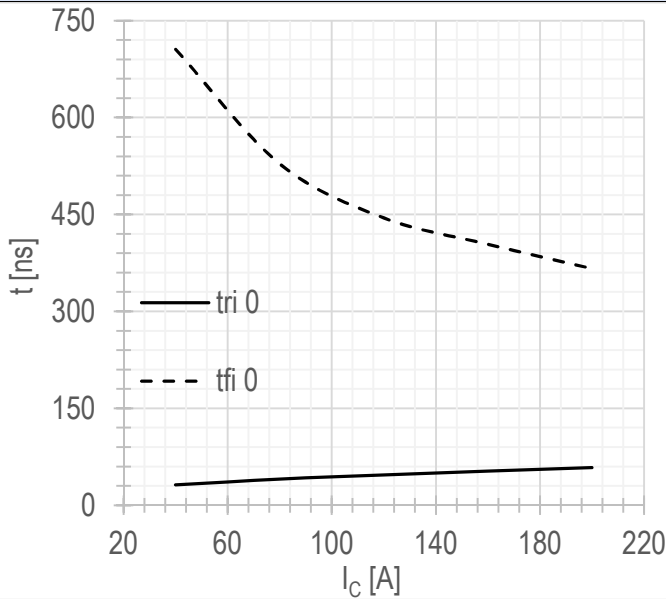
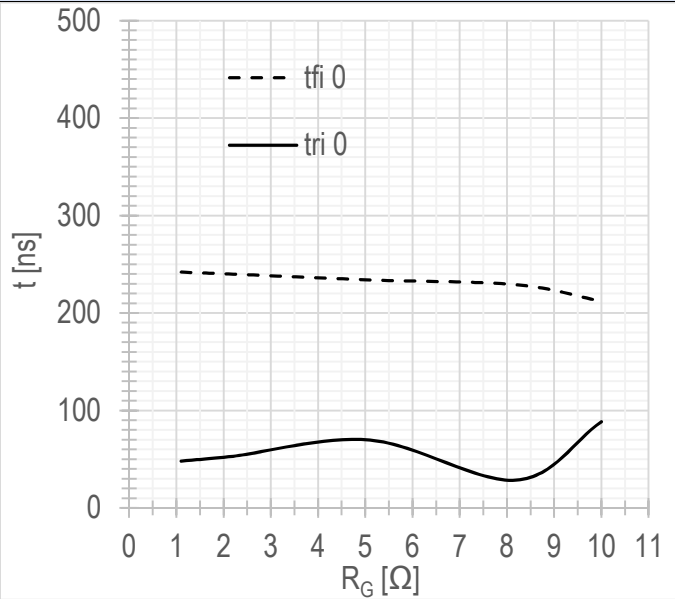
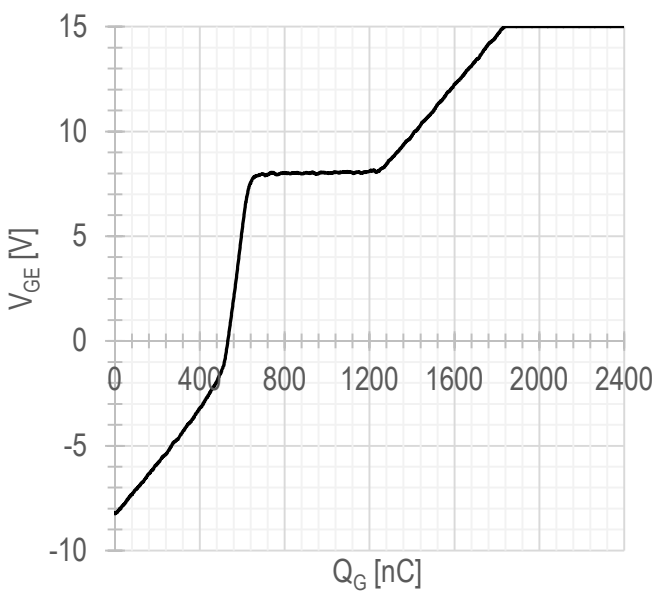
$V_{GE} = \pm 15$ V;
 $V_{CE} = 600$ V;
 $I_{Cmax} = 200$ A;
 $L = 300$ μ H;
 $T_{vj(max)} = 150^\circ\text{C}$.

Chart 15 – typ. gate charge characteristic.

$I_C = 200$ A;
 $V_{CE} = 600$ V;
 $V_{GE} = -8 \div 15$ V.

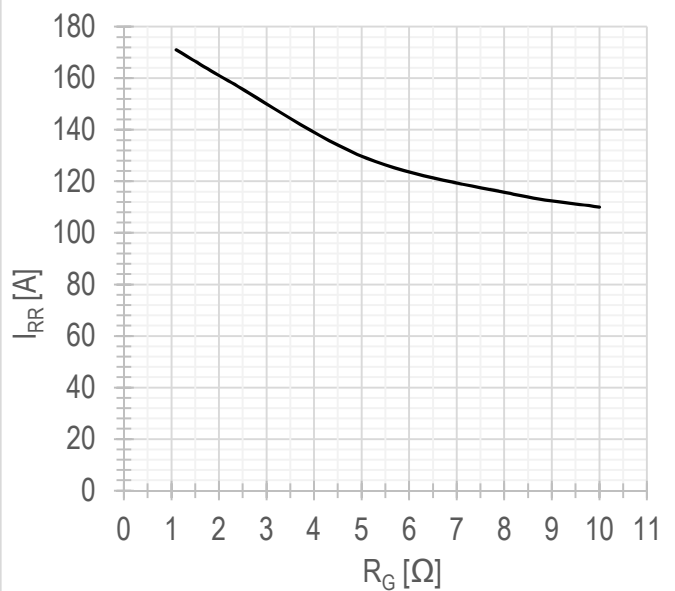
Chart 16 – typ. reverse recovery current vs gate resistance FRD.

$V_{GE} = \pm 15$ V;
 $V_{CE} = 600$ V;
 $I_{Cmax} = 200$ A;
 $L = 300$ μ H;
 $T_{vj(max)} = 150^\circ\text{C}$.

Chart 17 – typ. rated current vs frequency.

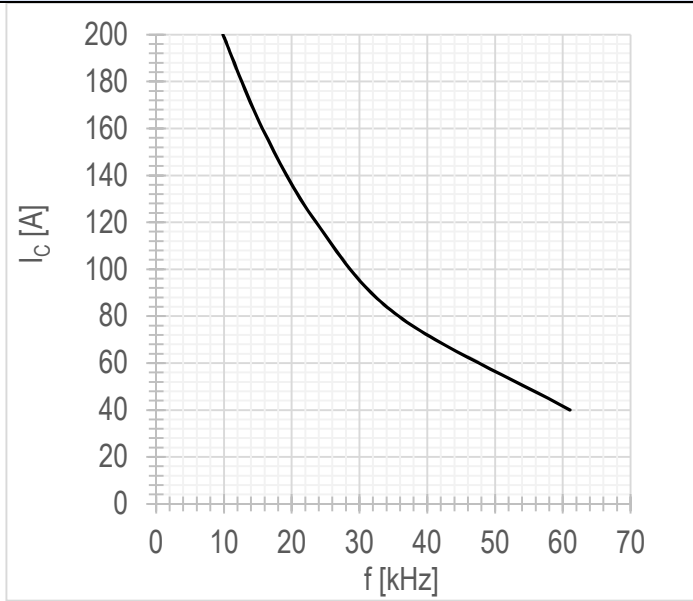

Duty cycle 50%

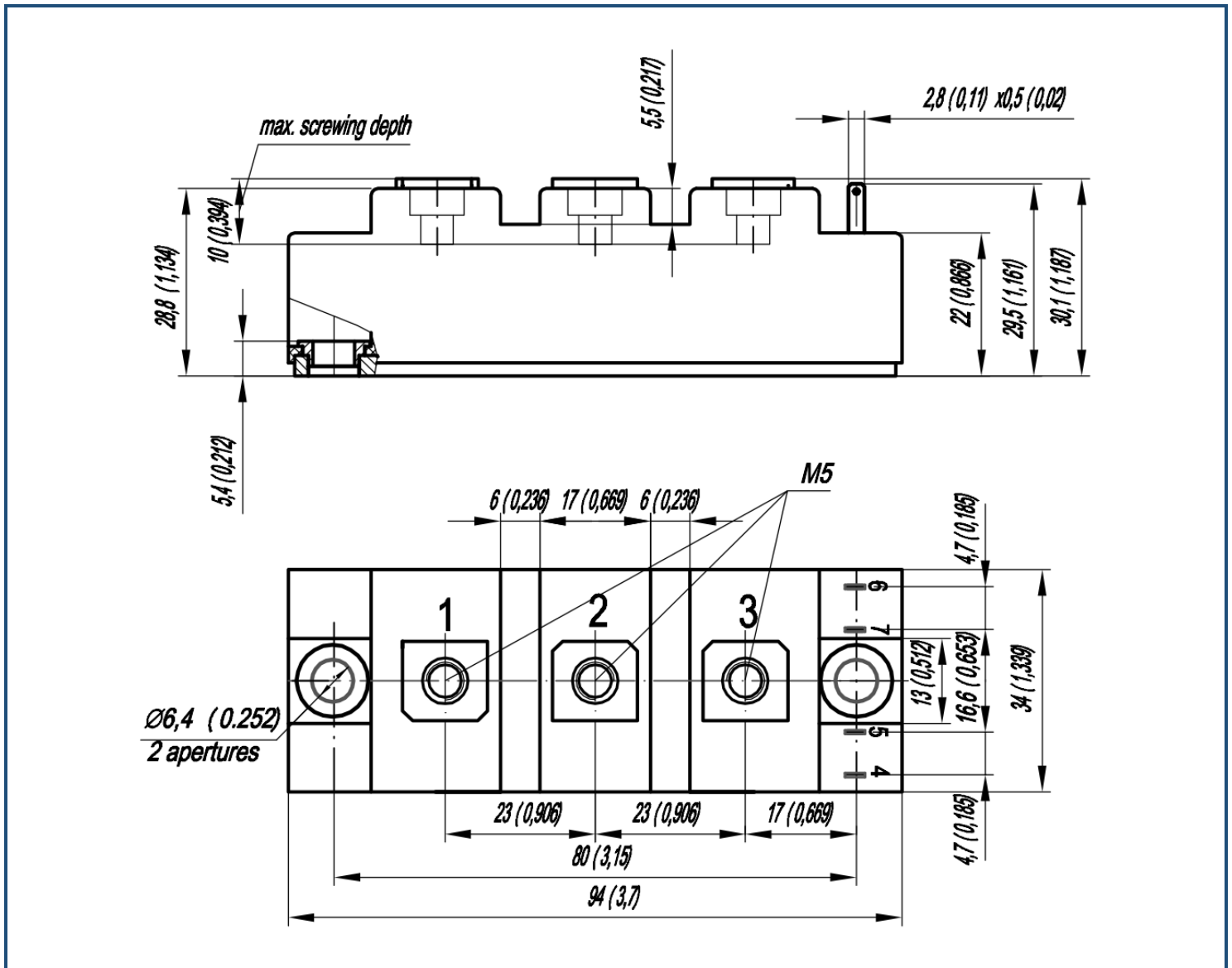
Overall dimensions: Package type – FA

Part numbering guide

MIFA	-	HB	12	FA	-	200	N	
MIFA								IGBT module package type: FA
		HB						2 switches as Half-Bridge
		HC						1 switch as High-Side chopper
		LC						1 switch as Low-Side chopper
			12					Voltage rating ($V_{CES}/100$)
				FA				IGBT+FRD chipset modification
						200		Current Rating
							N	Climatic version: normal climate

The information contained herein is protected by Copyright. In the interest of product improvement, Proton-Electrotex reserves the right to change datasheet without notice.