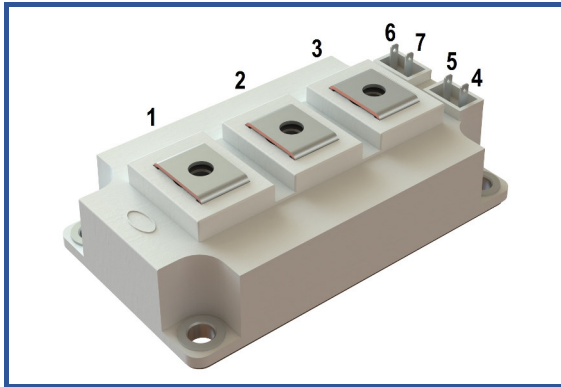

Industry standart 62mm IGBT module

1700 V 300 A

**Chip features**

- IGBT chip
  - Trench FS — V-Series IGBT ( 6<sup>th</sup> gen)
  - low  $V_{CE(sat)}$  value
  - 10  $\mu$ s short circuit of 150°C
  - square RBSOA of 2xI<sub>C</sub>
  - low EMI
- FRD chip
  - fast and soft reverse recovery
  - low voltage drop

**Design features**

- copper baseplate
- Al<sub>2</sub>O<sub>3</sub> DBC substrate
- ultrasonically welded power terminals
- Improved thermal cycling
- RoHS compliant

**Typical application**

- AC motor drivers
- solar inverter
- air conditioning
- high power converters and UPS

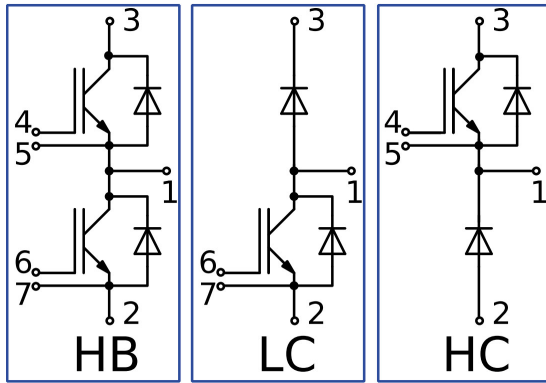
**Maximum rated values**

Definition	Symbol	Conditions	Value	Unit
<b>IGBT</b>				
Collector-Emitter voltage	$V_{CES}$	$V_{GE} = 0.$	1700	V
Collector current (nominal)	$I_{C\ nom}$		300	A
Collector current (maximum continuous)	$I_{C\ 25}$	$T_{vj\ (max)} = 175^{\circ}C; T_c = 25^{\circ}C.$	402	A
	$I_{C\ 80}$	$T_{vj\ (max)} = 175^{\circ}C; T_c = 80^{\circ}C.$	308	A
Repetitive peak collector current <sup>*1</sup>	$I_{CRM}$	$I_{CRM} = 3 \times I_{C\ nom}; t_p = 1\ ms.$	900	A
Short-circuit duration	$t_{psc}$	$T_{vj} = 25^{\circ}C; V_{GE} = \pm 15\ V; V_{CE} = 980\ V;$ $R_{G\ on} = R_{G\ off} = 2.2\ \Omega; I_{Cmax} < 1900\ A.$	10	$\mu$ s
		$T_{vj} = 150^{\circ}C; V_{GE} = \pm 15\ V; V_{CE} = 980V;$ $R_{G\ on} = R_{G\ off} = 2.2\ \Omega; I_{Cmax} < 1550\ A.$	10	
Gate-Emitter voltage	$V_{GES}$		$\pm 20$	V
Junction operating temperature	$T_{vj\ (op)}$		-40...+150	°C
<b>Inverse diode \ Freewheeling diode</b>				
Repetitive peak reverse voltage	$V_{RRM}$	$V_{GE} = 0\ V.$	1700	V
Forward current (nominal)	$I_{F\ nom}$		300	A
Forward current (maximum continuous)	$I_{F\ 25}$	$T_{vj\ (max)} = 175^{\circ}C; T_c = 25^{\circ}C.$	291	A
	$I_{F\ 80}$	$T_{vj\ (max)} = 175^{\circ}C; T_c = 80^{\circ}C.$	219	A
Repetitive peak forward current <sup>*1</sup>	$I_{FRM}$	$I_{FRM} = 3 \times I_{F\ nom}; t_p = 1\ ms.$	900	A
Junction operating temperature	$T_{vj\ (op)}$		-40...+150	°C
<b>Module</b>				
Storage temperature	$T_{stg}$		-40...+50	°C
Isolation voltage	$U_{isol}$	AC sin 50 Hz; t = 1 min.	4000	V

\*1 Pulse width and repetition rate should be such that device junction temperature does not exceed maximum  $T_{vj}$  rating.

**Characteristics**

Definition	Symbol	Conditions	Value			Unit.		
			min.	typ.	max.			
<b>IGBT</b>								
Collector-Emitter saturation voltage	$V_{CEsat}$	$V_{GE} = +15\text{ V}; I_C = 300\text{ A};$ $t_u = 1000\text{ }\mu\text{s}.$	$T_{vj} = 25^\circ\text{C}$ $T_{vj} = 150^\circ\text{C}$	2.13 2.95	2.16 3.23	2.33 3.57	V V	
Gate-Emitter threshold voltage	$V_{GE(th)}$	$I_C = 6\text{ mA}; V_{CE} = V_{GE}; T_{vj} = 25^\circ\text{C};$ $t_u = 2\text{ ms}.$		5.38	5.99	6.36	V	
Collector-Emitter cut-off current	$I_{CES}$	$V_{CE} = 1700\text{ V};$ $t_u = 10\text{ }\mu\text{s}; V_{GE} = 0.$	$T_{vj} = 25^\circ\text{C}$ $T_{vj} = 150^\circ\text{C}$	3.90 0.98	4.96 1.41	150 2.50	$\mu\text{A}$ mA	
Gate-Emitter leakage current	$I_{GES}$	$V_{CE} = 0; V_{GE} = \pm 20\text{ V}; T_{vj} = 25^\circ\text{C};$ $t_u = 30\text{ ms}.$		13.0	16.5	250	nA	
Input capacitance	$C_{ies}$	$V_{CE} = 10\text{ V}; V_{GE} = 0\text{ V};$ $f = 1\text{ MHz}; T_{vj} = 25^\circ\text{C}.$		-	27.2	-	nF	
Output capacitance	$C_{oes}$			-	1.40	-	nF	
Reverse transfer capacitance	$C_{res}$			-	2.80	-	nF	
Total gate charge	$Q_G$	$I_C = 300\text{ A}; V_{CE} = 850\text{ V};$ $V_{GE} = -8 \div 15\text{ V}.$		-	3483	3738	nC	
Internal gate resistance	$R_{Gint}$	$T_{vj} = 25^\circ\text{C}.$		-	2.50	-	$\Omega$	
Turn-on delay time	$t_{d(on)}$	$V_{CE} = 850\text{ V};$ $V_{GE} = \pm 15\text{ V};$ $I_{Cmax} = 300\text{ A};$ $R_G = 2.2\text{ }\Omega;$ $L = 300\text{ }\mu\text{H}.$	$T_{vj} = 25^\circ\text{C}$ $T_{vj} = 150^\circ\text{C}$	458 559	491 583	557 650	ns	
Rise time	$t_{ri}$		$T_{vj} = 25^\circ\text{C}$ $T_{vj} = 150^\circ\text{C}$	55.0 60.0	56.0 62.0	64.0 70.0	ns	
Turn-on energy	$E_{on}$		$T_{vj} = 25^\circ\text{C}$ $T_{vj} = 150^\circ\text{C}$	36.8 64.2	40.2 69.4	47.0 85.0	mJ	
Turn-off delay time	$t_{d(off)}$		$T_{vj} = 25^\circ\text{C}$ $T_{vj} = 150^\circ\text{C}$	652 823	682 849	755 935	ns	
Fall time	$t_{fi}$		$T_{vj} = 25^\circ\text{C}$ $T_{vj} = 150^\circ\text{C}$	462 556	473 593	520 715	ns	
Turn-off energy	$E_{off}$		$T_{vj} = 25^\circ\text{C}$ $T_{vj} = 150^\circ\text{C}$	59.6 81.9	61.2 84.4	68.0 100	mJ	
Collector-emitter threshold voltage	$V_{CE0}$		$V_{GE} = +15\text{ V}; T_{vj} = 150^\circ\text{C};$		0.98	1.02	1.07	V
On-State slope resistance (IGBT)	$r_{CE0}$		$I_{CE1} = 75\text{ A}; I_{CE2} = 300\text{ A};$ $t_u = 1000\text{ }\mu\text{s}.$		6.36	7.26	8.25	m $\Omega$
Thermal resistance junction to case	$R_{th(j-c)}$		DC; $I_{CE} = 220 \pm 10\text{ A}; I_{test} = 1.0\text{ A};$ $V_{GE} = +15\text{ V}.$		-	0.056	0.085	K/W
<b>Inverse diode \ Freewheeling diode</b>								
Forward voltage drop	$V_F$	$I_F = 300\text{ A};$ $V_{GE} = 0; t_u = 1000\text{ }\mu\text{s}.$	$T_{vj} = 25^\circ\text{C}$ $T_{vj} = 150^\circ\text{C}$	1.86 2.24	1.87 2.51	2.08 2.78	V V	
Reverse recovery time	$t_{rr}$	$V_{GE} = \pm 15\text{ V};$ $V_{CE} = 850\text{ V};$ $I_{Cmax} = 300\text{ A};$ $R_{Gon} = 2.2\text{ }\Omega;$ $L = 300\text{ }\mu\text{H}.$	$T_{vj} = 25^\circ\text{C}$ $T_{vj} = 150^\circ\text{C}$	518 978	558 1052	710 1230	ns ns	
Repetitive peak reverse current	$I_{RRM}$		$T_{vj} = 25^\circ\text{C}$ $T_{vj} = 150^\circ\text{C}$	300 323	328 358	365 400	A A	
Reverse recovered charge	$Q_{rr}$		$T_{vj} = 25^\circ\text{C}$ $T_{vj} = 150^\circ\text{C}$	49.6 97.1	51.2 98.9	60.0 110	$\mu\text{C}$ $\mu\text{C}$	
Reverse recovery energy	$E_{rec}$		$T_{vj} = 25^\circ\text{C}$ $T_{vj} = 150^\circ\text{C}$	31.5 59.2	32.9 61.0	38.0 68.0	mJ mJ	
Threshold voltage	$V_{(TO)}$		$T_{vj} = 150^\circ\text{C}; V_{GE} = 0; I_{CE1} = 75\text{ A};$		0.86	0.90	0.96	V
Forward slope resistance	$r_T$		$I_{CE2} = 300\text{ A}; t_u = 1000\text{ }\mu\text{s}$		4.40	5.19	6.00	m $\Omega$
Thermal resistance junction to case	$R_{th(JC-D)}$	DC; $I_{CE} = 200 \pm 10\text{ A}; I_{test} = 1.0\text{ A};$ $V_{GE} = +15\text{ V}.$		-	0.127	0.190	K/W	

Module							
Pin resistance	$R_{Pxy}$	$T_{vj} = 25^{\circ}\text{C}.$	$R_{P12}$	-	0.28	0.50	m $\Omega$
			$R_{P13}$	-	0.38	0.50	
Parasitic inductance between terminals	$L_{Pxy}$	$T_{vj} = 25^{\circ}\text{C};$ $f = 1 \text{ MHz}.$	$L_{P12}$	-	33.4	35.0	nH
			$L_{P13}$	-	56.0	60.0	
Thermal resistance case to heatsink	$R_{thCH}$	per module		-	0.02	0.04	K/W
Mounting torque for screws to heatsink	$M_s$	to heatsink M6		3	-	5	N*m
Mounting torque for terminal screws	$M_t$	to terminals M5		2.25	2.50	2.75	N*m
Weight	$W$			-	318	340	g

**Notes:**

- Insulating material operating temperature 125°C max;
- Case temperature 125°C max;
- The recommended operating junction temperature  $T_{vj\ op} = -40 \div +150^{\circ}\text{C}.$

Chart 1 – typ. output characteristic, IGBT.



 $V_{GE} = +15 \text{ V.}$ 

Chart 2 – typ. rated current vs temperature.

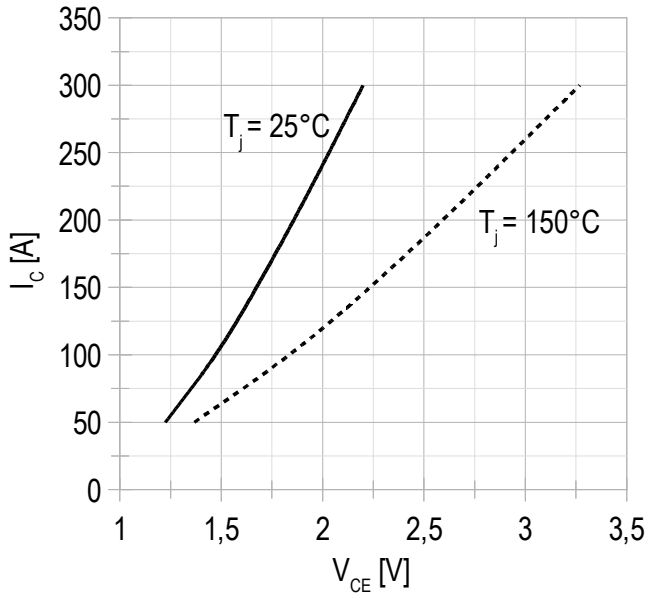
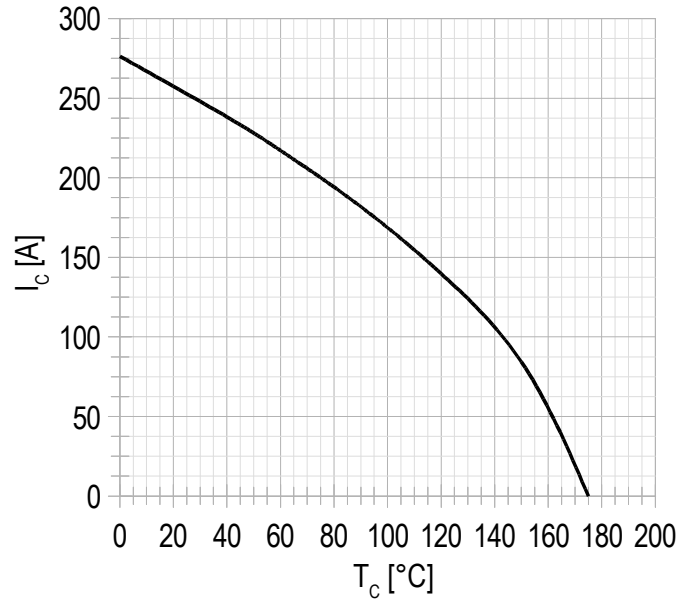
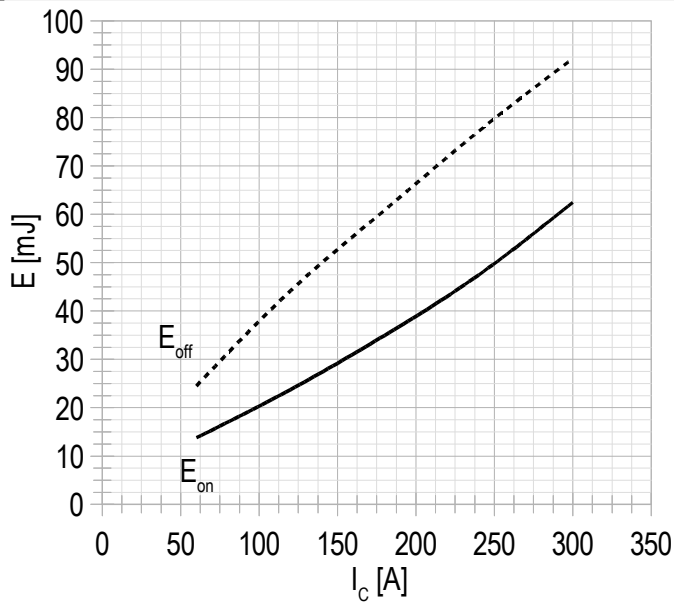

DC;  
 $V_{GE} = +15 \text{ V;}$   
 $T_{vj(max)} = 150^\circ\text{C.}$

Chart 3 – typ. turn-on/-off energy vs rated current, IGBT.



$V_{CE} = 850 \text{ V;}$   
 $V_{GE} = \pm 15 \text{ V;}$   
 $R_G = 2.2 \Omega;$   
 $L = 300 \mu\text{H;}$   
 $T_{vj(max)} = 150^\circ\text{C.}$

Chart 4 – typ. turn-on/-off energy vs gate resistance, IGBT.

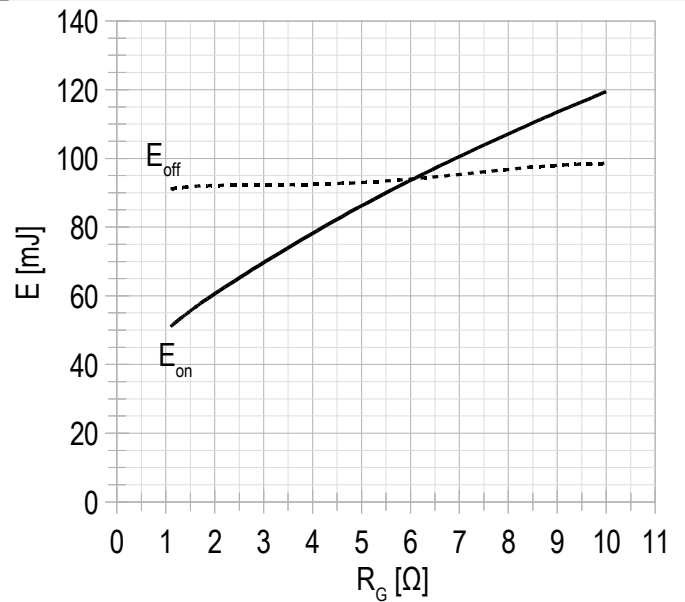

$V_{CE} = 850 \text{ V;}$   
 $V_{GE} = \pm 15 \text{ V;}$   
 $I_{Cmax} = 300 \text{ A;}$   
 $L = 300 \mu\text{H;}$   
 $T_{vj(max)} = 150^\circ\text{C.}$

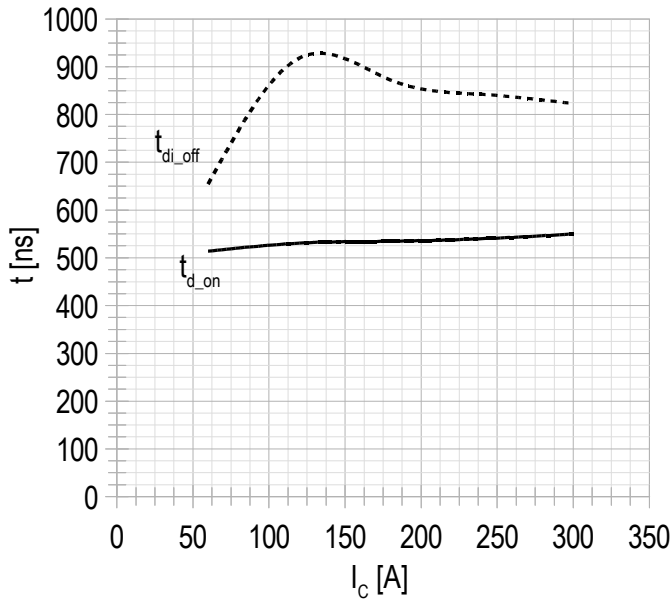
**Chart 5 – typ. switching times vs rated current, IGBT.**

$V_{CE} = 850 \text{ V};$   
 $V_{GE} = \pm 15 \text{ V};$   
 $R_G = 2.2 \ \Omega;$   
 $L = 300 \ \mu\text{H};$   
 $T_{vj(\text{max})} = 150^\circ\text{C}.$

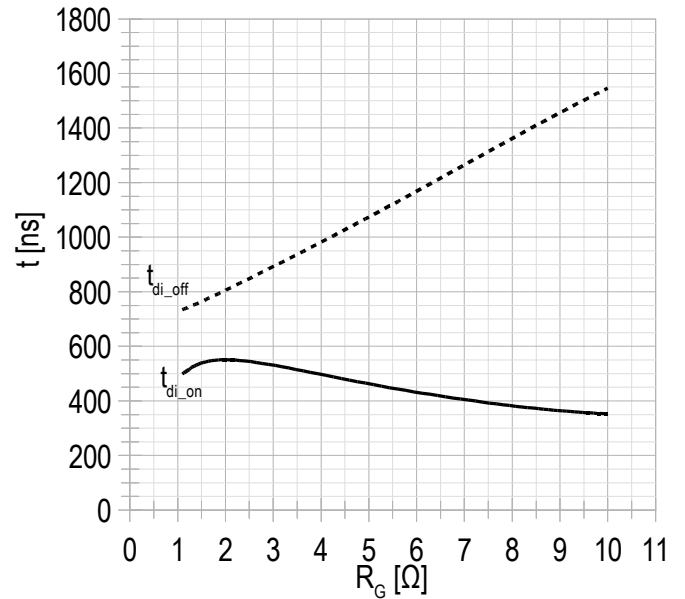
**Chart 6 – typ. switching times vs gate resistance, IGBT.**

$V_{CE} = 850 \text{ V};$   
 $V_{GE} = \pm 15 \text{ V};$   
 $I_{C \text{ max}} = 300 \text{ A};$   
 $L = 300 \ \mu\text{H};$   
 $T_{vj(\text{max})} = 150^\circ\text{C}.$

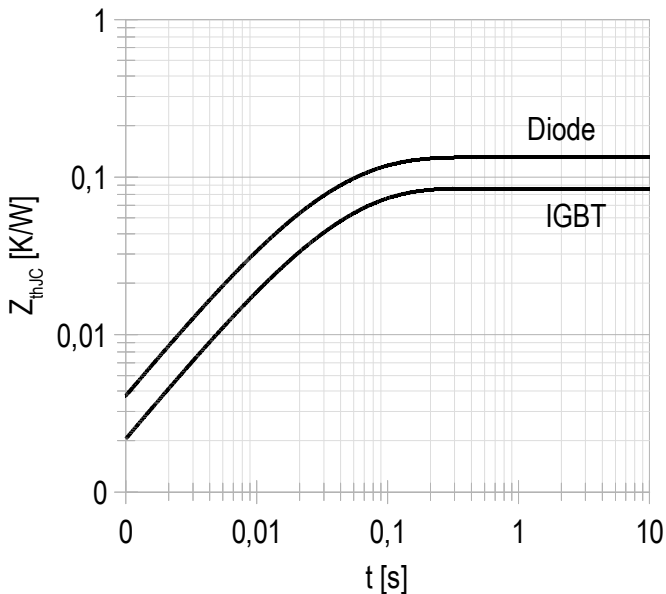
**Chart 7 – max. transient thermal impedance .**

Single pulse;  
 $V_{GE} = +15 \text{ V}.$

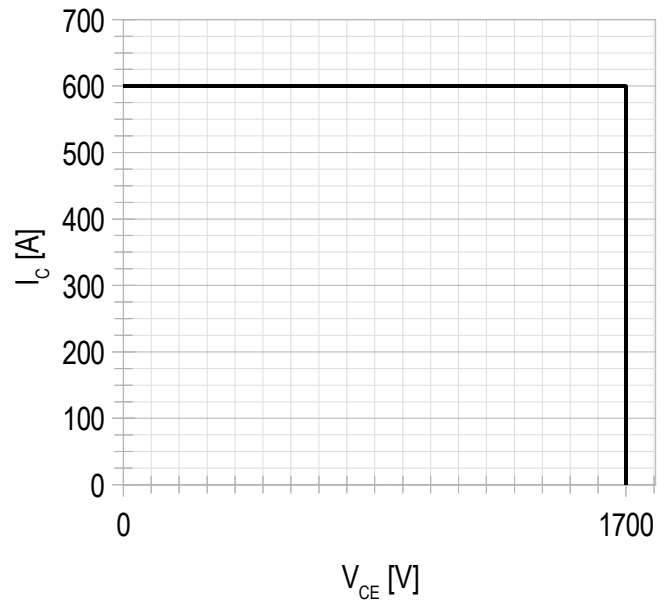
**Chart 8 – RBSOA.**

$V_{CE \text{ max}} = 1700 \text{ V};$   
 $V_{GE} = \pm 15 \text{ V};$   
 $I_{C \text{ max}} = 2 * I_{C \text{ nom}};$   
 $R_G = 2.2 \ \Omega;$   
 $L = 300 \ \text{мкГн}.$

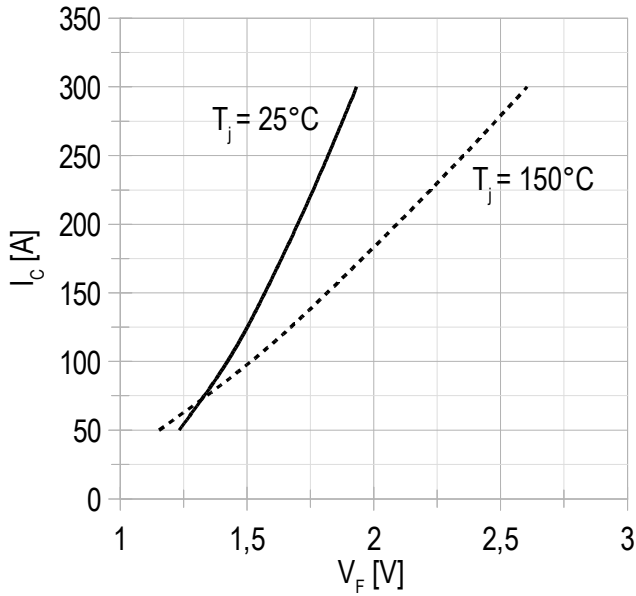
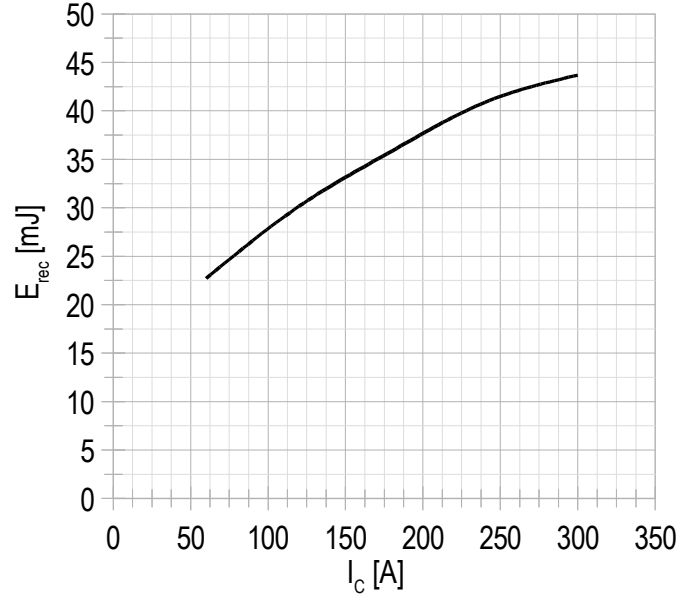
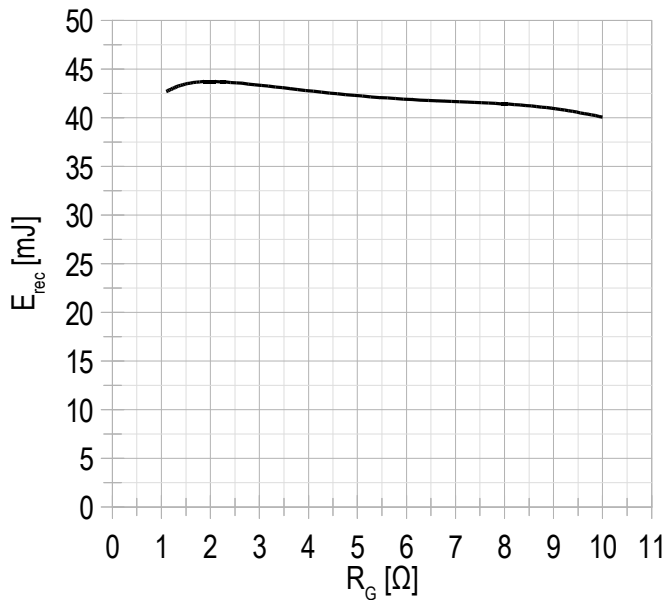
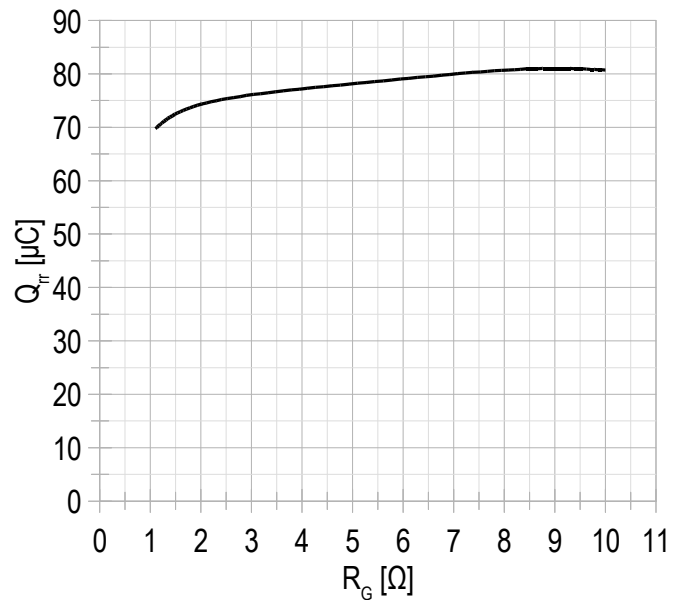
**Chart 9 – typ. output characteristic, FRD.**

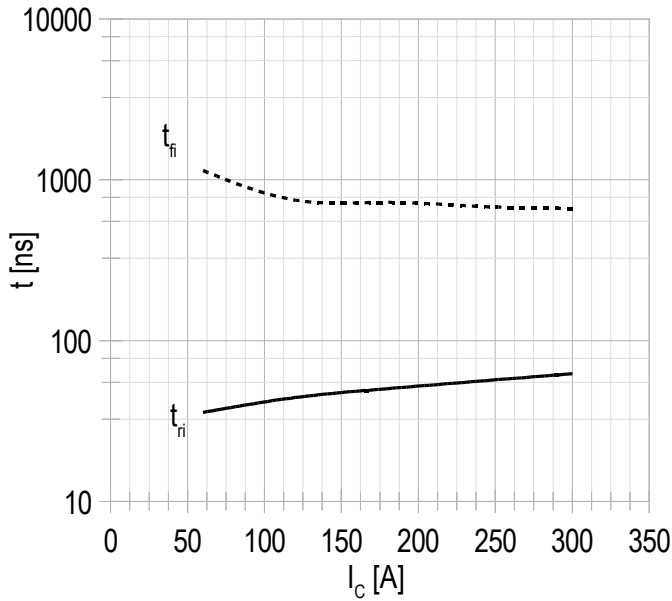
 $V_{GE} = +15\text{ V.}$ 
**Chart 10 – typ. switching losses vs rated current, FRD.**

 $V_{GE} = \pm 15\text{ V;}$   
 $V_{CE} = 850\text{ V;}$   
 $L = 300\ \mu\text{H;}$   
 $R_{G\ on} = 2.2\ \Omega;$   
 $T_{vj\ (max)} = 150^\circ\text{C.}$ 
**Chart 11 – typ. switching losses vs gate resistance, FRD.**

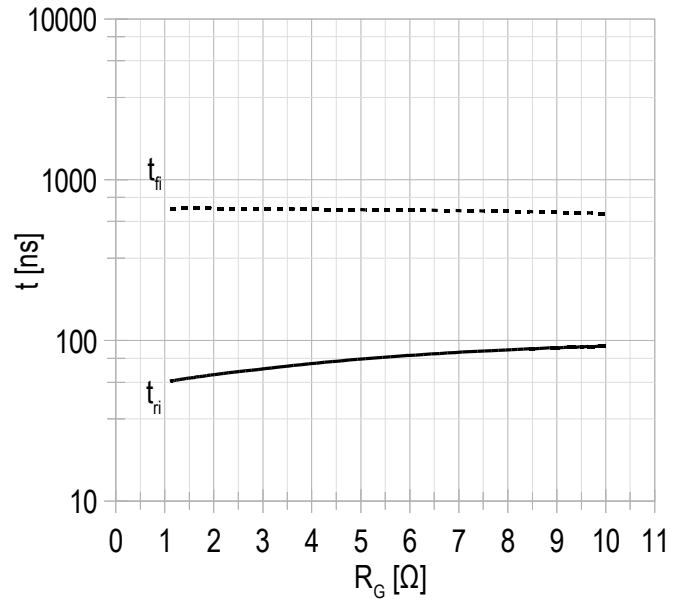
 $V_{GE} = \pm 15\text{ V;}$   
 $V_{CE} = 850\text{ V;}$   
 $I_{C\ max} = 300\text{ A;}$   
 $L = 300\ \mu\text{H;}$   
 $T_{vj\ (max)} = 150^\circ\text{C.}$ 
**Chart 12 – typ. reverse recovered charge vs gate resistance, FRD.**

 $V_{GE} = \pm 15\text{ V;}$   
 $V_{CE} = 850\text{ V;}$   
 $I_{C\ max} = 300\text{ A;}$   
 $L = 300\ \mu\text{H;}$   
 $T_{vj\ (max)} = 150^\circ\text{C.}$

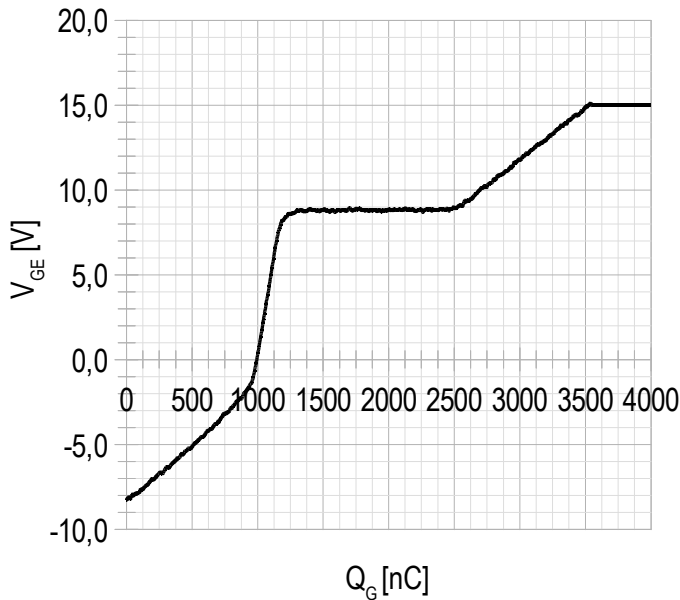
**Chart 13 – typ. switching times vs rated current, FRD.**

$V_{CE} = 850$  V;  
 $V_{GE} = \pm 15$  V;  
 $R_G = 2.2$   $\Omega$ ;  
 $L = 300$   $\mu$ H.  
 $T_{vj(max)} = 150^\circ$ C.

**Chart 14 – typ. switching times vs gate resistance, FRD.**

$V_{CE} = 850$  V;  
 $V_{GE} = \pm 15$  V;  
 $I_{Cmax} = 300$  A;  
 $L = 300$   $\mu$ H.  
 $T_{vj(max)} = 150^\circ$ C.

**Chart 15 – typ. gate charge characteristic.**

$I_c = 300$  A;  
 $V_{CE} = 850$  V;  
 $V_{GE} = -8 \div 15$  V.

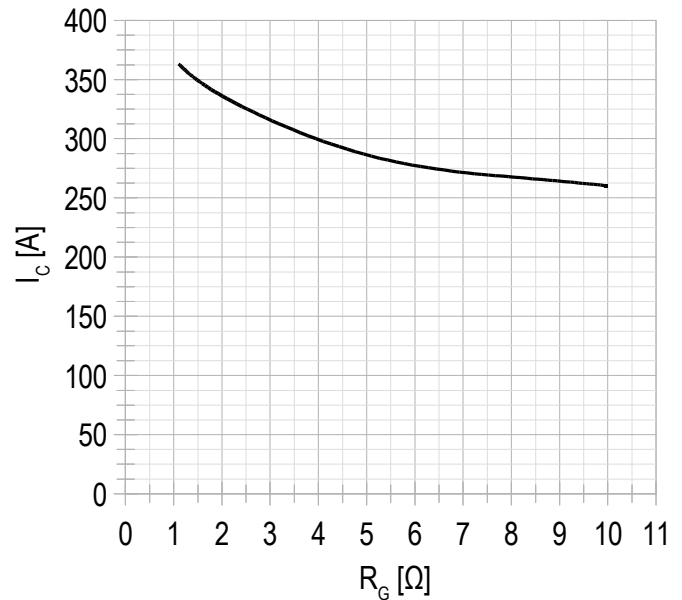
**Chart 16 – typ. reverse recovery current vs gate resistance FRD.**

$V_{CE} = 850$  V;  
 $V_{GE} = \pm 15$  V;  
 $L = 300$   $\mu$ H;  
 $T_{vj(max)} = 150^\circ$ C.

Chart 17 – typ. rated current vs frequency.

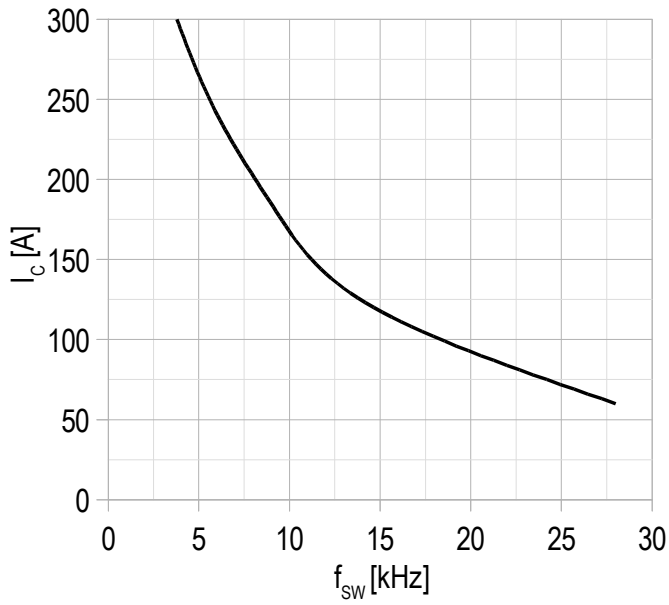

Duty cycle 50%

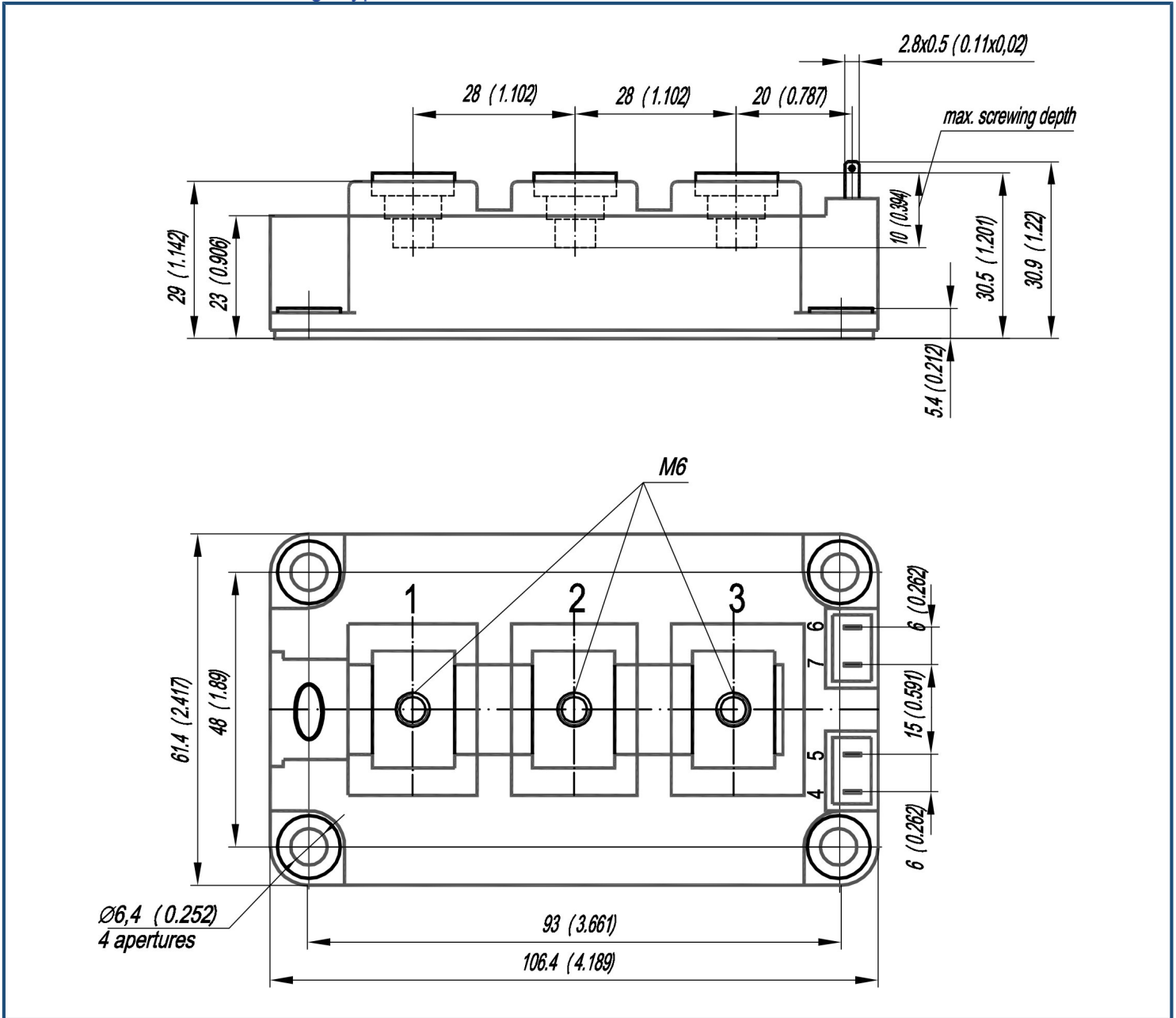

**Overall dimensions: Package type – AA**

**Part numbering guide**

MIAA	-	HB	17	AA	-	300	N	
MIAA								IGBT module package type: AA
		HB						2 switches as Half-Bridge
		HC						1 switch as High-Side chopper
		LC						1 switch as Low-Side chopper
			17					Voltage rating ( $V_{CES}/100$ )
				AA				IGBT+FRD chipset modification
					300			Current Rating
							N	Climatic version: normal climate

The information contained herein is protected by Copyright. In the interest of product improvement, Proton-Electrotex reserves the right to change datasheet without notice.