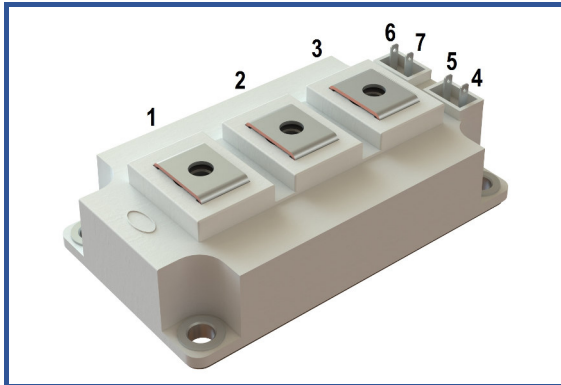

## Industry standart 62mm IGBT module

1700 V 200 A

**Chip features**

- IGBT chip
  - Trench FS — V-Series IGBT ( 6<sup>th</sup> gen)
  - low  $V_{CE(sat)}$  value
  - 10  $\mu$ s short circuit of 150°C
  - square RBSOA of 2xI<sub>C</sub>
  - low EMI
- FRD chip
  - fast and soft reverse recovery
  - low voltage drop

**Design features**

- copper baseplate
- Al<sub>2</sub>O<sub>3</sub> DBC substrate
- ultrasonically welded power terminals
- Improved thermal cycling
- RoHS compliant

**Typical application**

- AC motor drivers
- solar inverter
- air conditioning
- high power converters and UPS

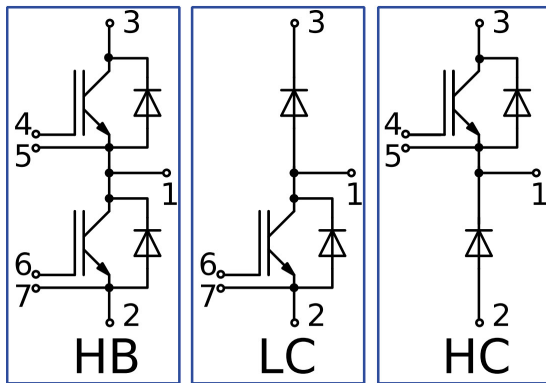
**Maximum rated values**

Definition	Symbol	Conditions	Value	Unit
<b>IGBT</b>				
Collector-Emitter voltage	$V_{CES}$	$V_{GE} = 0.$	1700	V
Collector current (nominal)	$I_{C\ nom}$		200	A
Collector current (maximum continuous)	$I_{C\ 25}$	$T_{vj\ (max)} = 175^{\circ}C; T_c = 25^{\circ}C.$	300	A
	$I_{C\ 80}$	$T_{vj\ (max)} = 175^{\circ}C; T_c = 80^{\circ}C.$	229	A
Repetitive peak collector current <sup>*1</sup>	$I_{CRM}$	$I_{CRM} = 3 \times I_{C\ nom}; t_p = 1\ ms.$	600	A
Short-circuit duration	$t_{psc}$	$T_{vj} = 25^{\circ}C; V_{GE} = \pm 15\ V; V_{CE} = 1000V;$ $R_{G\ on} = R_{G\ off} = 2.2\ \Omega; I_{Cmax} < 1300\ A.$	10	$\mu$ s
		$T_{vj} = 150^{\circ}C; V_{GE} = \pm 15\ V; V_{CE} = 1000V;$ $R_{G\ on} = R_{G\ off} = 2.2\ \Omega; I_{Cmax} < 1200\ A.$	10	
Gate-Emitter voltage	$U_{GES}$		$\pm 20$	V
Junction operating temperature	$T_{vj\ (op)}$		-40...+150	°C
<b>Inverse diode \ Freewheeling diode</b>				
Repetitive peak reverse voltage	$V_{RRM}$	$V_{GE} = 0\ V.$	1700	V
Forward current (nominal)	$I_{F\ nom}$		200	A
Forward current (maximum continuous)	$I_{F\ 25}$	$T_{vj\ (max)} = 175^{\circ}C; T_c = 25^{\circ}C.$	227	A
	$I_{F\ 80}$	$T_{vj\ (max)} = 175^{\circ}C; T_c = 80^{\circ}C.$	169	A
Repetitive peak forward current <sup>*1</sup>	$I_{FRM}$	$I_{FRM} = 3 \times I_{F\ nom}; t_p = 1\ ms.$	600	A
Junction operating temperature	$T_{vj\ (op)}$		-40...+150	°C
<b>Module</b>				
Storage temperature	$T_{stg}$		-40...+50	°C
Isolation voltage	$V_{isol}$	AC sin 50 Hz; t = 1 min.	4000	V

\*1 Pulse width and repetition rate should be such that device junction temperature does not exceed maximum  $T_{vj}$  rating.

**Characteristics**

Definition	Symbol	Conditions	Value			Unit.		
			min.	typ.	max.			
<b>IGBT</b>								
Collector-Emitter saturation voltage	$V_{CEsat}$	$V_{GE} = +15\text{ V}; I_C = 200\text{ A}; t_u = 1000\ \mu\text{s}.$	$T_{vj} = 25^\circ\text{C}$ $T_{vj} = 150^\circ\text{C}$	2.06 2.62	2.09 2.68	2.27 2.87	V V	
Gate-Emitter threshold voltage	$V_{GE(th)}$	$I_C = 8\text{ mA}; V_{CE} = V_{GE}; T_{vj} = 25^\circ\text{C}; t_u = 2\text{ ms}.$		5.24	5.92	6.28	V	
Collector-Emitter cut-off current	$I_{CES}$	$V_{CE} = 1700\text{ V}; t_u = 10\text{ ms}; V_{GE} = 0.$	$T_{vj} = 25^\circ\text{C}$ $T_{vj} = 150^\circ\text{C}$	3.62 0.97	4.42 1.20	150 1.5	$\mu\text{A}$ mA	
Gate-Emitter leakage current	$I_{GES}$	$V_{CE} = 0; V_{GE} = \pm 20\text{ V}; T_{vj} = 25^\circ\text{C}; t_u = 30\text{ ms}.$		10.4	13.8	200	nA	
Input capacitance	$C_{ies}$	$V_{CE} = 10\text{ V}; V_{GE} = 0\text{ V}; f = 1\text{ MHz}; T_{vj} = 25^\circ\text{C}.$		-	19.8	-	nF	
Output capacitance	$C_{oes}$			-	1.00	-	nF	
Reverse transfer capacitance	$C_{res}$			-	1.60	-	nF	
Total gate charge	$Q_G$	$I_C = 200\text{ A}; V_{CE} = 850\text{ V}; V_{GE} = -8 \div 15\text{ V}.$		-	2336	2520	nC	
Internal gate resistance	$R_{Gint}$	$T_{vj} = 25^\circ\text{C}.$		-	3.75	-	$\Omega$	
Turn-on delay time	$t_{d(on)}$	$V_{CE} = 850\text{ V}; V_{GE} = \pm 15\text{ V}; I_{Cmax} = 200\text{ A}; R_G = 2.2\ \Omega; L = 300\ \mu\text{H}.$	$T_{vj} = 25^\circ\text{C}$ $T_{vj} = 150^\circ\text{C}$	446 513	463 523	523 587	ns	
Rise time	$t_{ri}$		$T_{vj} = 25^\circ\text{C}$ $T_{vj} = 150^\circ\text{C}$	42.0 46.0	44.0 49.0	51.0 57.0	ns	
Turn-on energy	$E_{on}$		$T_{vj} = 25^\circ\text{C}$ $T_{vj} = 150^\circ\text{C}$	24.8 44.4	26.8 45.9	32.0 55.0	mJ	
Turn-off delay time	$t_{d(off)}$		$T_{vj} = 25^\circ\text{C}$ $T_{vj} = 150^\circ\text{C}$	535 659	540 729	610 827	ns	
Fall time	$t_{fi}$		$T_{vj} = 25^\circ\text{C}$ $T_{vj} = 150^\circ\text{C}$	529 637	546 707	614 800	ns	
Turn-off energy	$E_{off}$		$T_{vj} = 25^\circ\text{C}$ $T_{vj} = 150^\circ\text{C}$	40.8 57.9	42.3 62.1	50.0 70.0	mJ	
Collector-emitter threshold voltage	$V_{CE0}$		$V_{GE} = +15\text{ V}; T_{vj} = 150^\circ\text{C}; I_{CE1} = 50\text{ A}; I_{CE2} = 200\text{ A}; t_u = 1000\ \mu\text{s}.$		0.98	1.00	1.07	V
On-State slope resistance (IGBT)	$r_{CE0}$				8.13	8.39	9.03	m $\Omega$
Thermal resistance junction to case	$R_{th(j-c)}$		DC; $I_{CE} = 150 \pm 10\text{ A}; I_{test} = 0.5\text{ A}; V_{GE} = +15\text{ V}.$		-	0.126	0.132	K/W
<b>Inverse diode \ Freewheeling diode</b>								
Forward voltage drop	$V_F$	$I_F = 200\text{ A}; V_{GE} = 0; t_u = 1000\ \mu\text{s}.$	$T_{vj} = 25^\circ\text{C}$ $T_{vj} = 150^\circ\text{C}$	1.82 2.04	1.85 2.10	2.00 2.25	V V	
Reverse recovery time	$t_{rr}$	$V_{GE} = \pm 15\text{ V}; V_{CE} = 850\text{ V}; I_{Cmax} = 200\text{ A}; R_{Gon} = 2.2\ \Omega; L = 300\ \mu\text{H}.$	$T_{vj} = 25^\circ\text{C}$ $T_{vj} = 150^\circ\text{C}$	428 794	501 873	620 1075	ns ns	
Repetitive peak reverse current	$I_{RRM}$		$T_{vj} = 25^\circ\text{C}$ $T_{vj} = 150^\circ\text{C}$	255 268	264 282	307 330	A A	
Reverse recovered charge	$Q_{rr}$		$T_{vj} = 25^\circ\text{C}$ $T_{vj} = 150^\circ\text{C}$	34.9 62.4	37.2 63.9	45.0 74.0	$\mu\text{C}$ $\mu\text{C}$	
Reverse recovery energy	$E_{rec}$		$T_{vj} = 25^\circ\text{C}$ $T_{vj} = 150^\circ\text{C}$	21.4 36.9	23.7 38.6	29.0 45.0	mJ mJ	
Threshold voltage	$V_{(TO)}$		$T_{vj} = 150^\circ\text{C}; V_{GE} = 0; I_{CE1} = 50\text{ A}; I_{CE2} = 200\text{ A}; t_u = 1000\ \mu\text{s}.$		0.91	0.92	0.98	V
Forward slope resistance	$r_T$				5.60	5.85	6.37	m $\Omega$
Thermal resistance junction to case	$R_{th(JC-D)}$	DC; $I_{CE} = 80 \pm 10\text{ A}; I_{test} = 0.5\text{ A}; V_{GE} = +15\text{ V}.$		-	0.254	0.280	K/W	

Module							
Pin resistance	$R_{Pxy}$	$T_{vj} = 25^{\circ}\text{C}.$	$R_{P12}$	-	0.47	0.50	m $\Omega$
			$R_{P13}$	-	0.66	0.66	
Parasitic inductance between terminals	$L_{Pxy}$	$T_{vj} = 25^{\circ}\text{C};$ $f = 1 \text{ MHz}.$	$L_{P12}$	-	33.4	35.0	nH
			$L_{P13}$	-	56.0	60.0	
Thermal resistance case to heatsink	$R_{thCH}$	per module		-	0.02	0.04	K/W
Mounting torque for screws to heatsink	$M_s$	to heatsink M6		3	-	5	N*m
Mounting torque for terminal screws	$M_t$	to terminals M5		2.25	2.50	2.75	N*m
Weight	$W$			-	318	340	g

**Notes:**

- Insulating material operating temperature 125°C max;
- Case temperature 125°C max;
- The recommended operating junction temperature  $T_{vj\ op} = -40 \div +150^{\circ}\text{C}.$

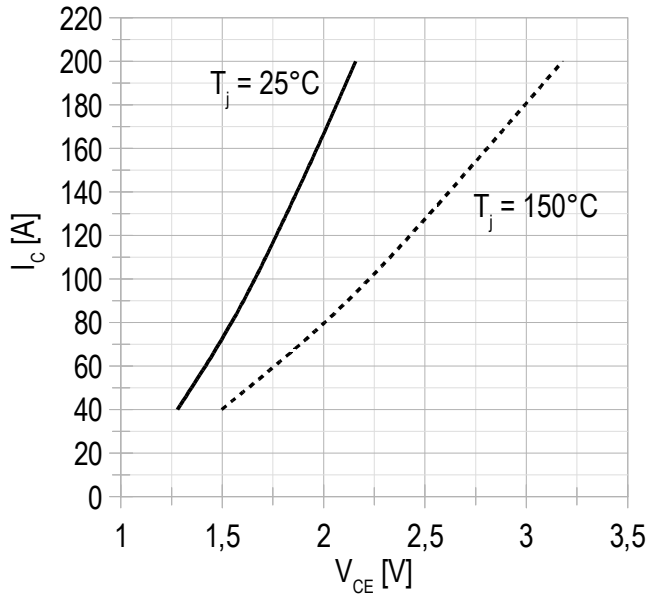
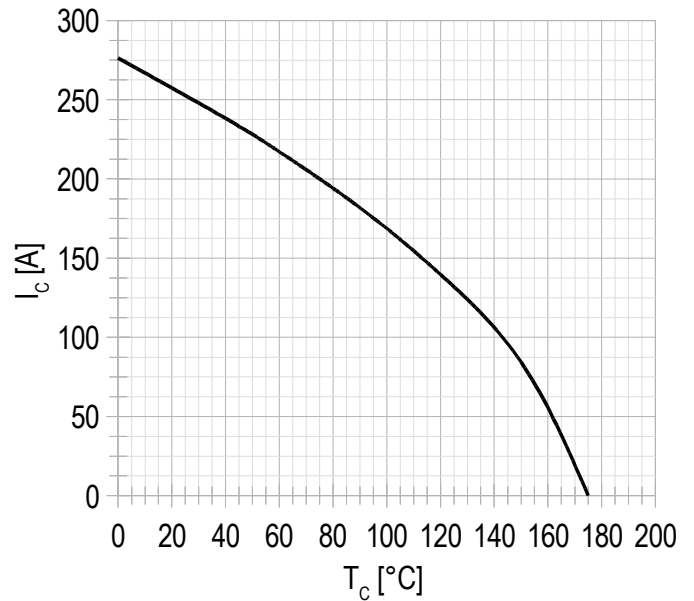
**Chart 1 – typ. output characteristic, IGBT.**

 $V_{GE} = +15 \text{ V.}$ 
**Chart 2 – typ. rated current vs temperature.**

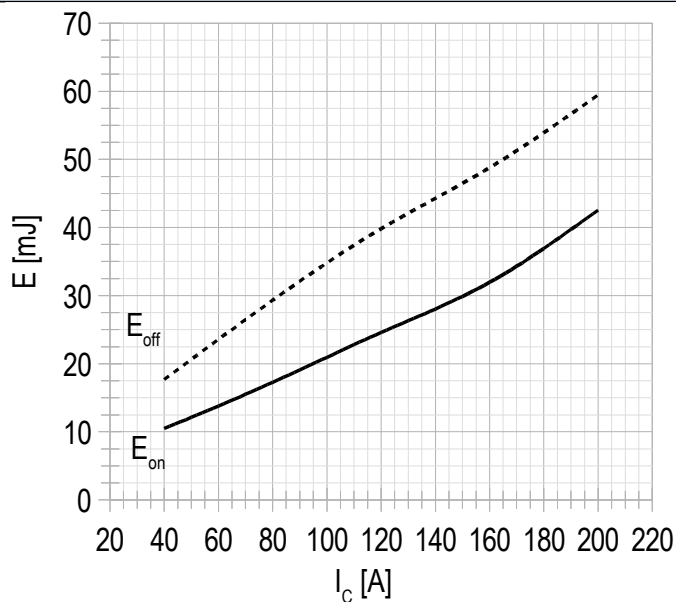
DC;  
 $V_{GE} = +15 \text{ V};$   
 $T_{vj(max)} = 150^\circ\text{C}.$

**Chart 3 – typ. turn-on/-off energy vs rated current, IGBT.**

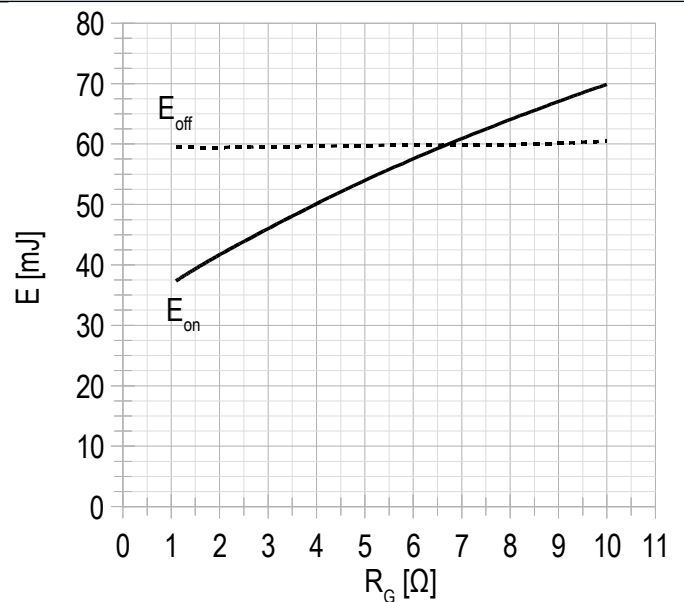
$V_{CE} = 850 \text{ V};$   
 $V_{GE} = \pm 15 \text{ V};$   
 $R_G = 2.2 \Omega;$   
 $L = 300 \mu\text{H};$   
 $T_{vj(max)} = 150^\circ\text{C}.$

**Chart 4 – typ. turn-on/-off energy vs gate resistance, IGBT.**

$V_{CE} = 850 \text{ V};$   
 $V_{GE} = \pm 15 \text{ V};$   
 $I_{Cmax} = 200 \text{ A};$   
 $L = 300 \mu\text{H};$   
 $T_{vj(max)} = 150^\circ\text{C}.$

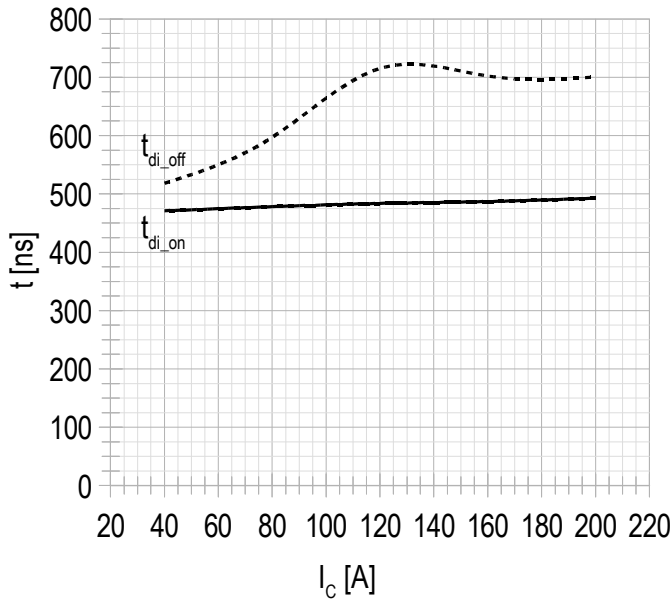
**Chart 5 – typ. switching times vs rated current, IGBT.**

$V_{CE} = 850 \text{ V};$   
 $V_{GE} = \pm 15 \text{ V};$   
 $R_G = 2.2 \text{ } \Omega;$   
 $L = 300 \text{ } \mu\text{H};$   
 $T_{vj(\text{max})} = 150^\circ\text{C}.$

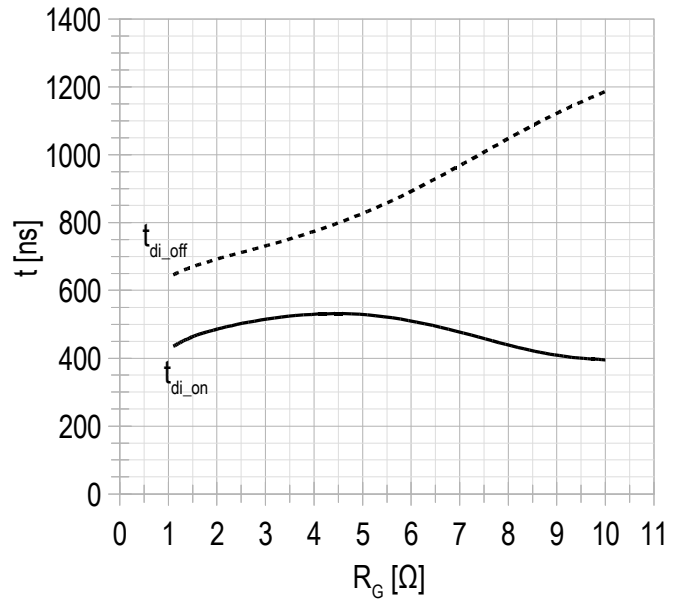
**Chart 6 – typ. switching times vs gate resistance, IGBT.**

$V_{CE} = 850 \text{ V};$   
 $V_{GE} = \pm 15 \text{ V};$   
 $I_{C \text{ max}} = 200 \text{ A};$   
 $L = 300 \text{ } \mu\text{H};$   
 $T_{vj(\text{max})} = 150^\circ\text{C}.$

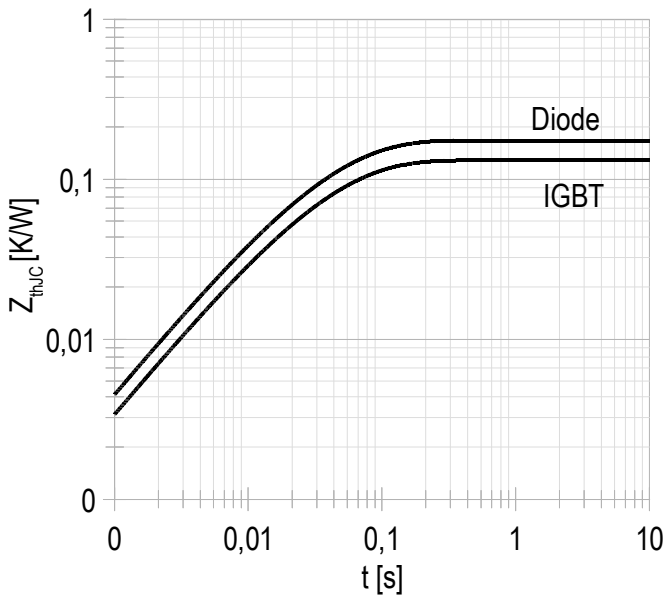
**Chart 7 – max. transient thermal impedance .**

Single pulse;  
 $V_{GE} = +15 \text{ V}.$

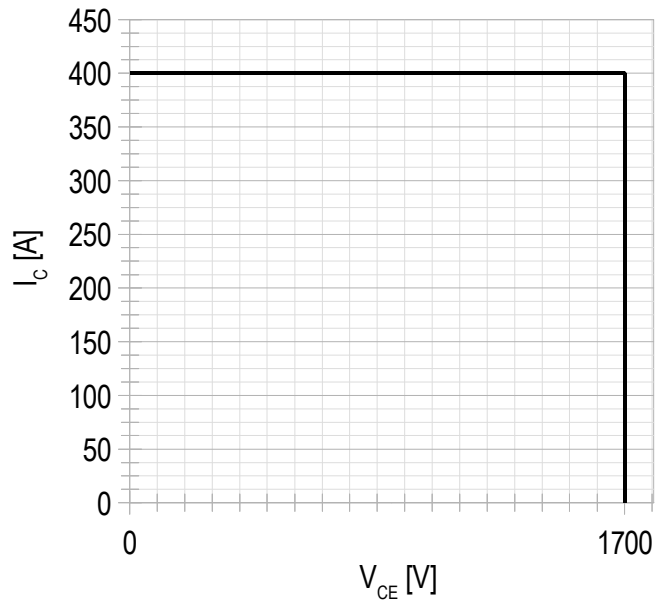
**Chart 8 – RBSOA.**

$V_{CE \text{ max}} = 1700 \text{ V};$   
 $V_{GE} = \pm 15 \text{ V};$   
 $I_{C \text{ max}} = 2 * I_{C \text{ nom}};$   
 $R_G = 2.2 \text{ } \Omega;$   
 $L = 300 \text{ } \mu\text{H}.$

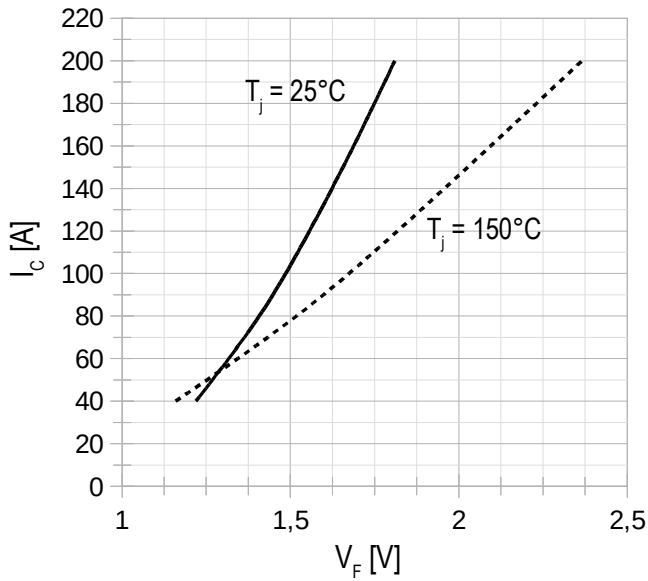
**Chart 9 – typ. output characteristic, FRD.**

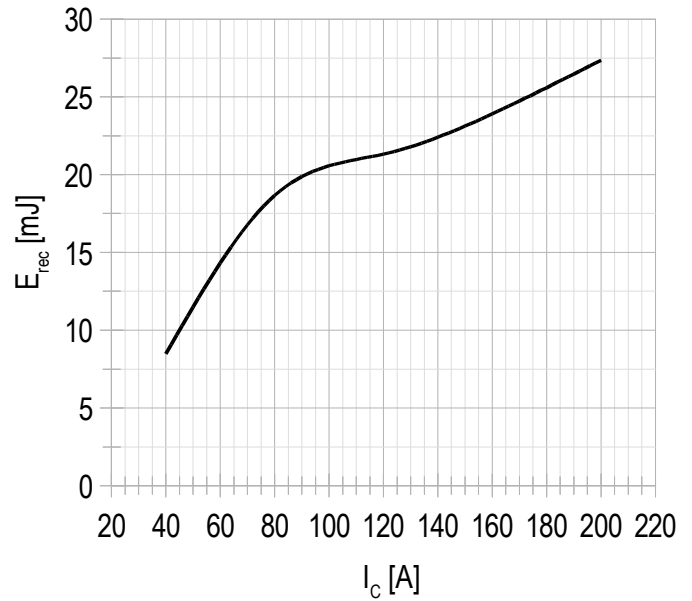
 $V_{GE} = +15\text{ V}$ .

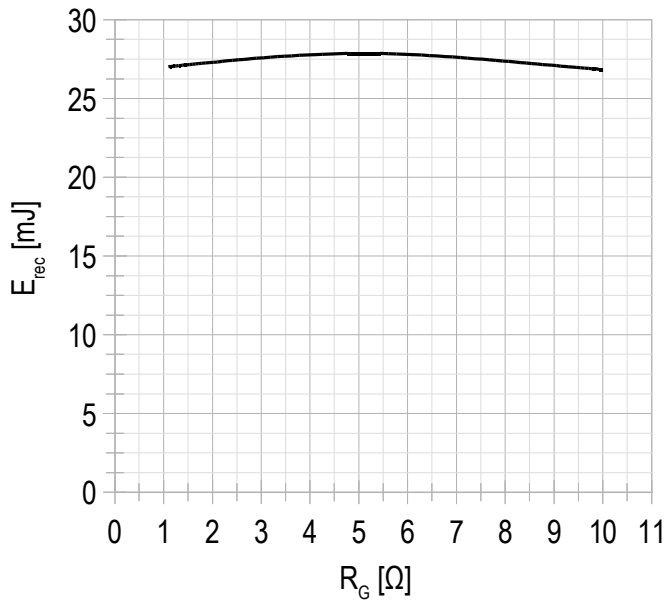
**Chart 10 – typ. switching losses vs rated current, FRD.**

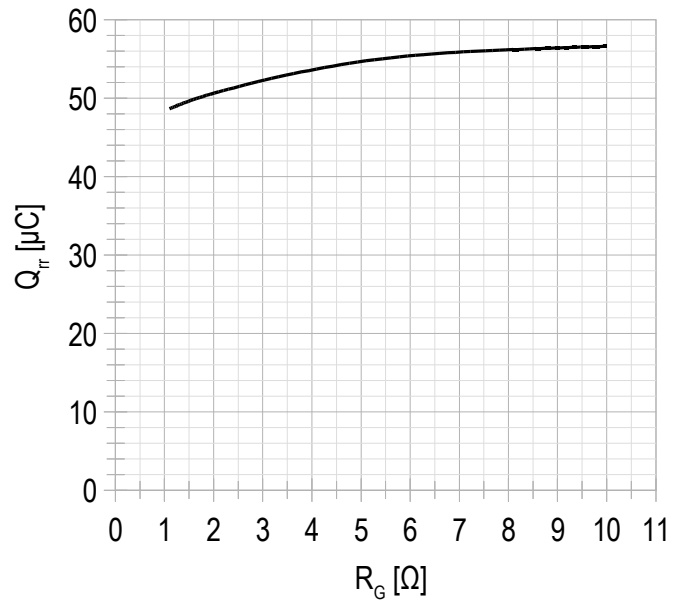
 $V_{GE} = \pm 15\text{ V}$ ;  
 $V_{CE} = 850\text{ V}$ ;  
 $L = 300\ \mu\text{H}$ ;  
 $R_{G\text{ on}} = 2.2\ \Omega$ ;  
 $T_{vj(\text{max})} = 150^\circ\text{C}$ .

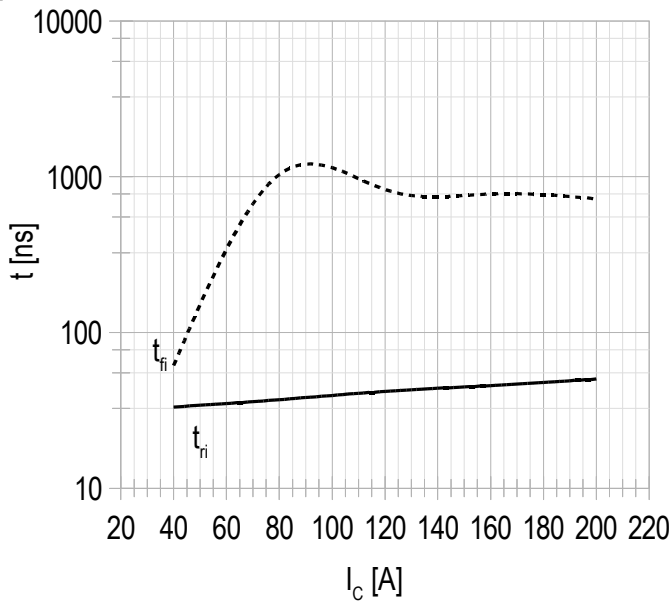
**Chart 11 – typ. switching losses vs gate resistance, FRD.**

 $V_{GE} = \pm 15\text{ V}$ ;  
 $V_{CE} = 850\text{ V}$ ;  
 $I_{C\text{ max}} = 200\text{ A}$ ;  
 $L = 300\ \mu\text{H}$ ;  
 $T_{vj(\text{max})} = 150^\circ\text{C}$ .

**Chart 12 – typ. reverse recovered charge vs gate resistance, FRD.**

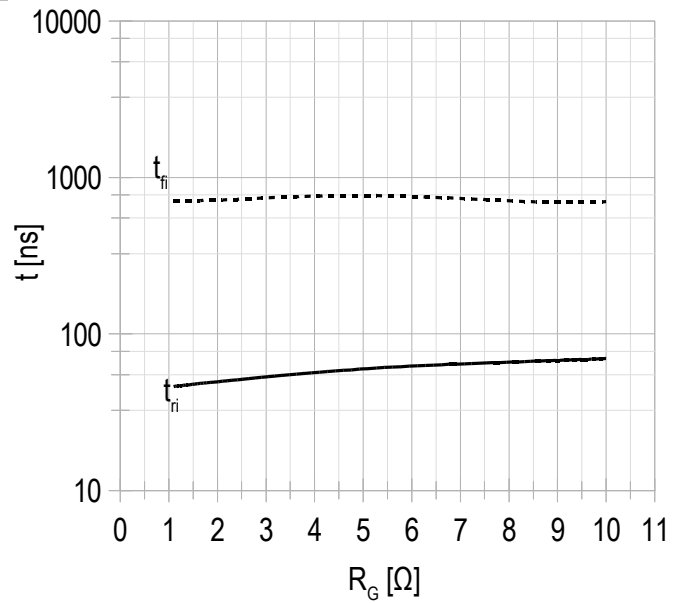
 $V_{GE} = \pm 15\text{ V}$ ;  
 $V_{CE} = 850\text{ V}$ ;  
 $I_{C\text{ max}} = 200\text{ A}$ ;  
 $L = 300\ \mu\text{H}$ ;  
 $T_{vj(\text{max})} = 150^\circ\text{C}$ .

**Chart 13 – typ. switching times vs rated current, FRD.**

$V_{CE} = 850 \text{ V};$   
 $V_{GE} = \pm 15 \text{ V};$   
 $R_G = 2.2 \text{ } \Omega;$   
 $L = 300 \text{ } \mu\text{H};$   
 $T_{vj(max)} = 150^\circ\text{C}.$

**Chart 14 – typ. switching times vs gate resistance, FRD.**

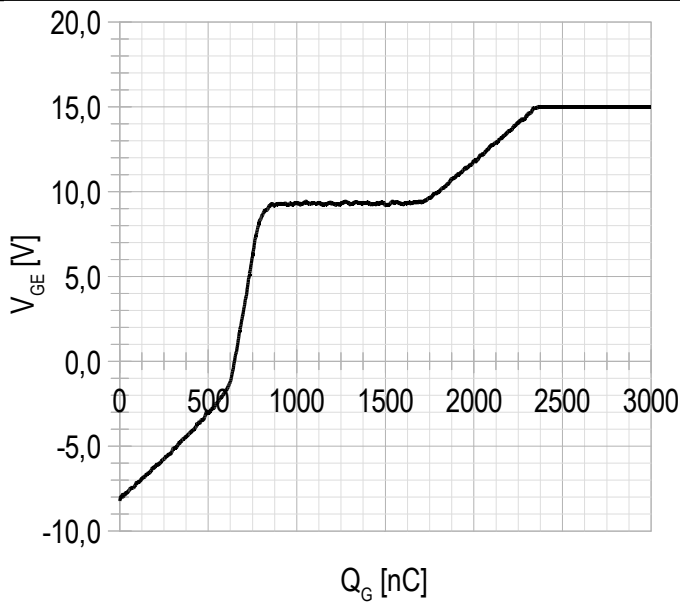
$V_{CE} = 850 \text{ V};$   
 $U_{GE} = \pm 15 \text{ V};$   
 $I_{Cmax} = 200 \text{ A};$   
 $L = 300 \text{ } \mu\text{H};$   
 $T_{vj(max)} = 150^\circ\text{C}.$

**Chart 15 – typ. gate charge characteristic.**

$I_C = 200 \text{ A};$   
 $V_{CE} = 850 \text{ V};$   
 $V_{GE} = -8 \div 15 \text{ V}.$

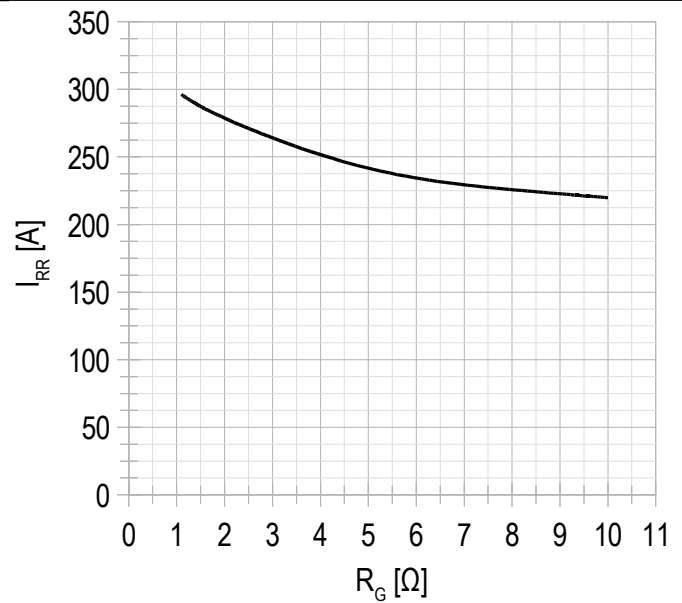
**Chart 16 – typ. reverse recovery current vs gate resistance FRD.**

$V_{CE} = 850 \text{ V};$   
 $V_{GE} = \pm 15 \text{ V};$   
 $L = 300 \text{ } \mu\text{H}.$   
 $T_{vj(max)} = 150^\circ\text{C}.$

Chart 17 – typ. rated current vs frequency.

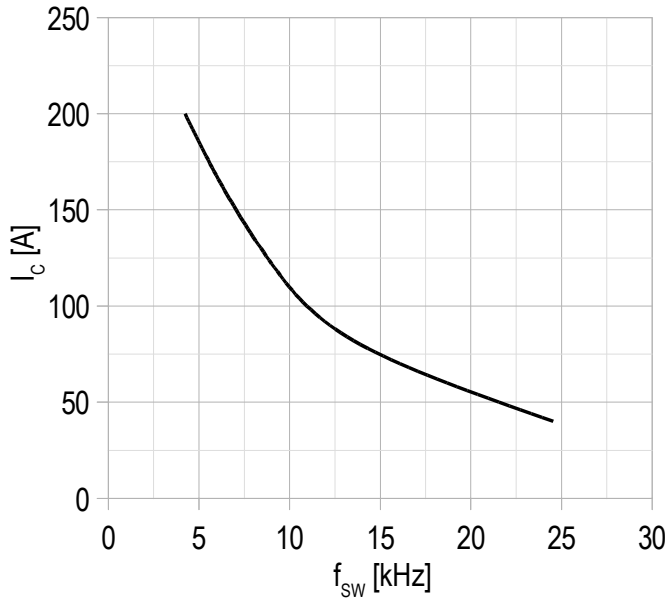

Duty cycle 50%

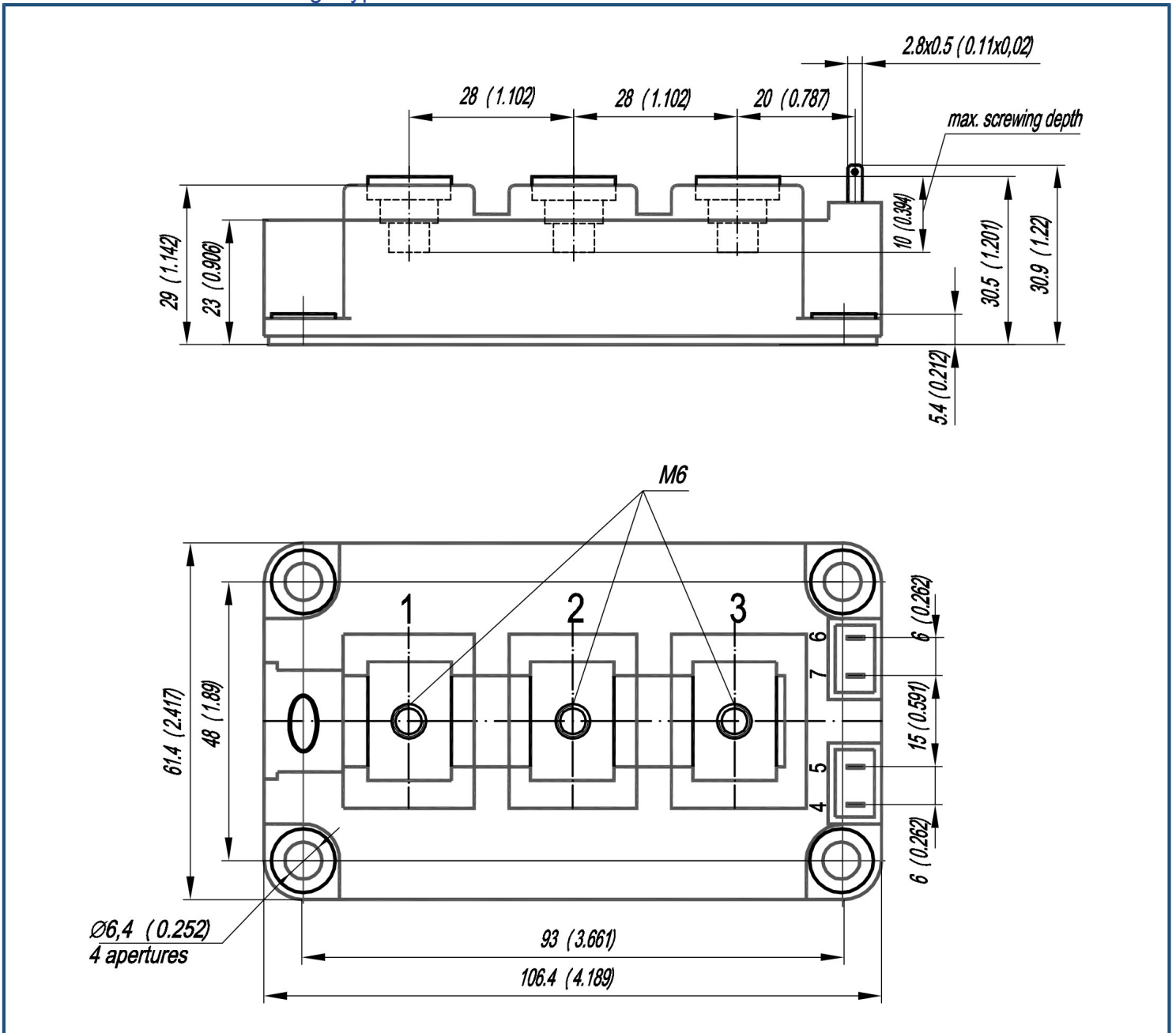

**Overall dimensions: Package type – AA**

**Part numbering guide**

MIAA	-	HB	17	AA	-	200	N	
MIAA								IGBT module package type: AA
		HB						2 switches as Half-Bridge
		HC						1 switch as High-Side chopper
		LC						1 switch as Low-Side chopper
			17					Voltage rating ( $V_{CE}/100$ )
				AA				IGBT+FRD chipset modification
					200			Current Rating
							N	Climatic version: normal climate

The information contained herein is protected by Copyright. In the interest of product improvement, Proton-Electrotex reserves the right to change datasheet without notice.